

# Dolphin PROX 2 Gyro Pool Cleaner

<b>EN</b>	<b>Operating Instructions</b> Dolphin PROX 2 Gyro Pool Cleaner.....	p.	1-10
<b>FR</b>	<b>Instructions d'opération</b> Dolphin PROX 2 Gyro nettoyeur de piscine.....	p.	11-20
<b>IT</b>	<b>Istruzioni per l'uso</b> Dolphin PROX 2 Gyro pulitore per piscina.....	p.	21-30
<b>ES</b>	<b>Instrucciones de manejo</b> Dolphin PROX 2 Gyro de piscinas.....	p.	31-40
<b>DE</b>	<b>Bedienungsanleitung</b> Dolphin PROX 2 Gyro Pool Reiniger.....	s.	41-50
<b>NL</b>	<b>Werkwijze instructies</b> Dolphin PROX 2 Gyro zwembadreiniger.....	p.	51-60
<b>PT</b>	<b>Instruções de operação</b> Dolphin PROX 2 Gyro limpador de piscinas.....	p.	61-70
<b>RU</b>	<b>Руководство по эксплуатации</b> Dolphin PROX 2 Gyro очиститель бассейнов.....	стр.	71-80





**EN**

# Dolphin PROX 2 Gyro Robotic Pool Cleaner

## Operating Instructions

---

### Contents

1. INTRODUCTION .....	2
2. SPECIFICATIONS .....	2
3. WARNINGS AND CAUTIONS.....	2
3.1. Warnings.....	2
3.2. Cautions.....	2
4. POOL CLEANER PARTS.....	3
5. USING THE POOL CLEANER.....	4
5.1. Setup.....	4
5.2. Putting the Pool Cleaner into the pool.....	5
5.3. Removing the Pool Cleaner from the pool.....	5
5.4. Maintenance.....	6
5.5. Off-season storage .....	7
6. POWER SUPPLY .....	8
7. REMOTE CONTROL UNIT .....	9
CADDY ASSEMBLY .....	81

# Dolphin PROX 2 Gyro Pool Cleaner

## Operating Instructions

### 1. INTRODUCTION

Thank you for purchasing a Maytronics Robotic Pool Cleaner.

We are sure that your Maytronics Robotic Pool Cleaner will provide you with reliable, convenient and cost effective pool cleaning. Its reliable filtration in all pool conditions and all-surface climbing brush enhance maximum pool hygiene.

The Robotic Pool Cleaners by Maytronics deliver advanced cleaning technologies, long lasting performance and easy maintenance.

### 2. SPECIFICATIONS

Motor protection: IP 68

Minimum depth: 0.80m/2.6ft

Maximum depth: 5m/16.4ft

### 3. WARNINGS AND CAUTIONS

#### 3.1. Warnings



- Use the originally supplied power supply only
- Ensure the electrical outlet is protected by a ground fault interrupter (GFI) or an earth leakage interrupter (ELI)
- Keep the power supply out of standing water
- Position the power supply at least 3m/10ft away from the edge of the pool
- Do not enter the pool while the pool cleaner is working
- Unplug the power supply before servicing

#### 3.2. Cautions

When not in use store the Pool Cleaner on the Caddy in a shaded area.

Use the Pool Cleaner in the following water conditions only:

Chlorine	Max 4 ppm
pH	7.0 - 7.8
Temperature	6 – 34°C (43-93°F)
NaCl	Maximum = 5000 ppm

## 4. POOL CLEANER PARTS

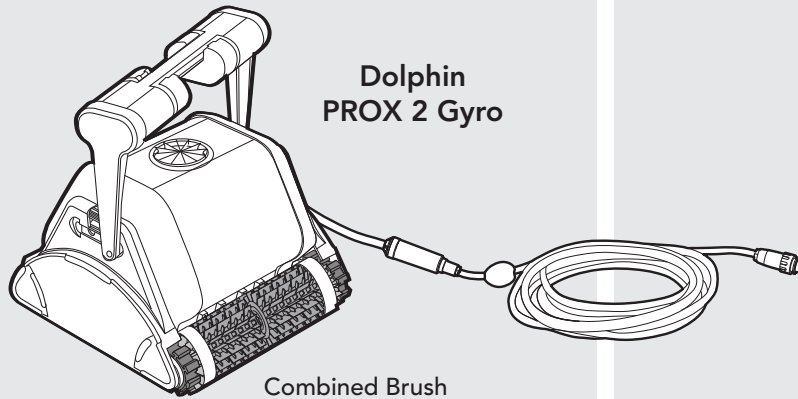

**Dolphin PROX 2 Gyro**

**Combined Brush**  
For rough ceramics  
Surface and mosaic tiles

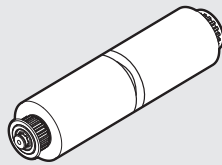

**Wonder Brush**  
For smooth ceramics  
(optional)

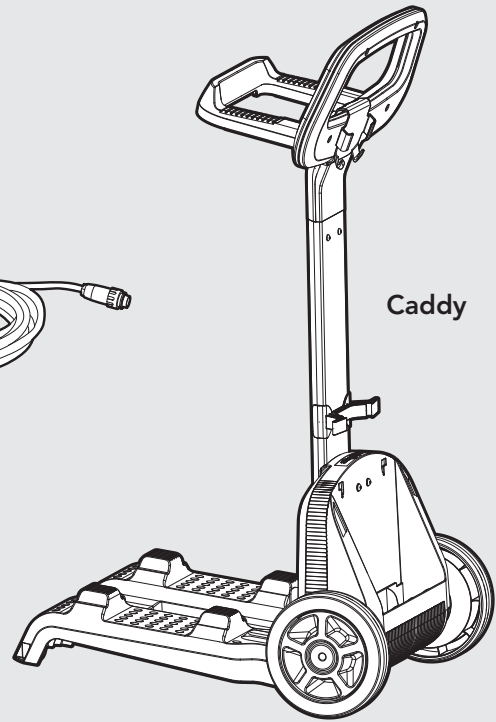

**Caddy**

**Bottom lid and filter Bag**

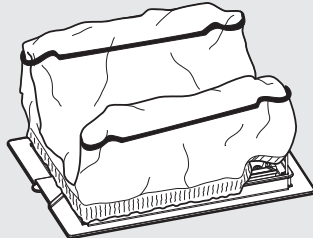

**Filter bag options:**  
Fine - default  
Ultra fine - extra



**Remote Control Unit**

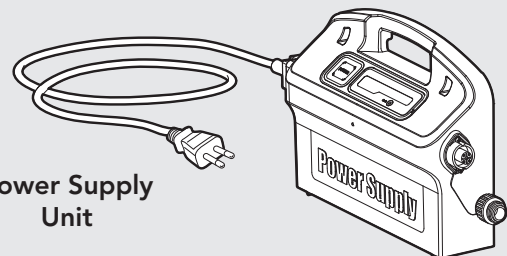

**Power Supply Unit**

## 5. USING THE POOL CLEANER

### 5.1. Set Up

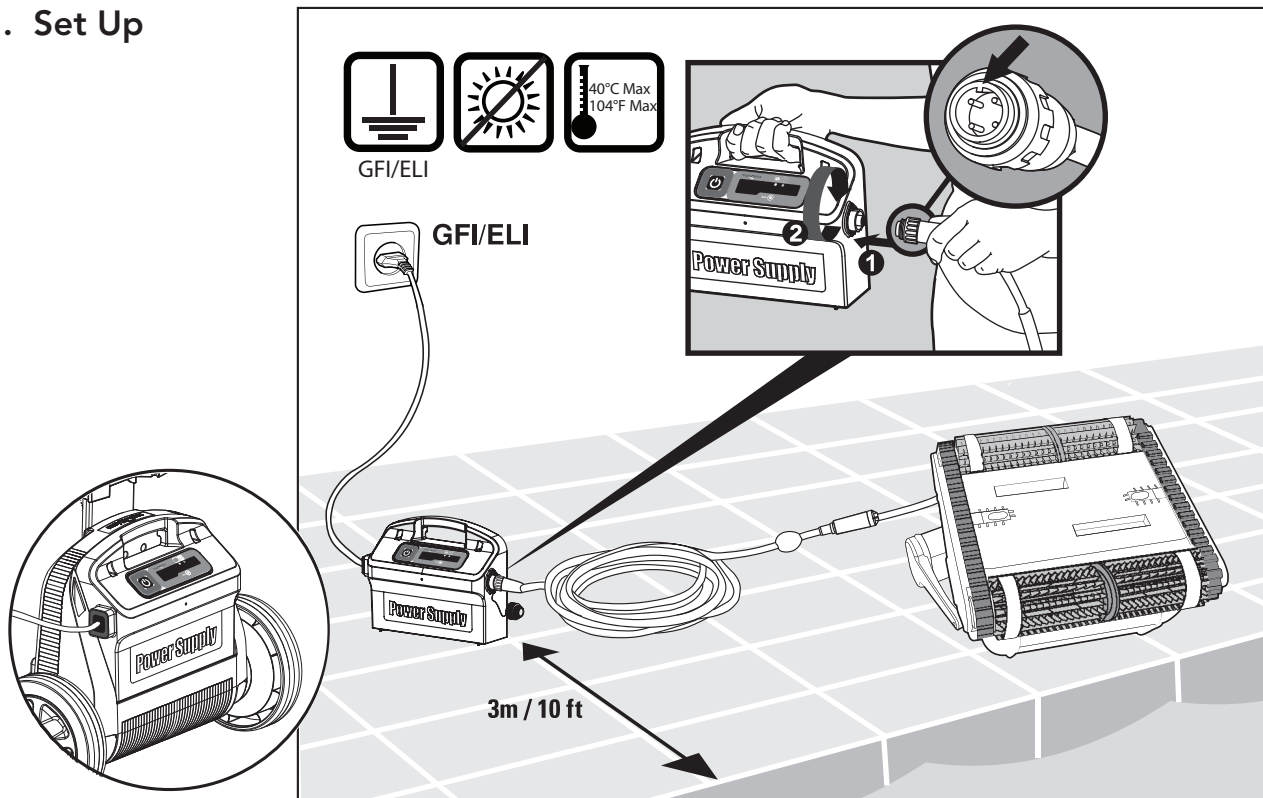

Change diagonal handle position for water line sideways movement.

To adjust the handle angle:

- A. Press the latch down and hold it in position.
- B. Move the handle to the desired position and release the latch to hold the handle in place.

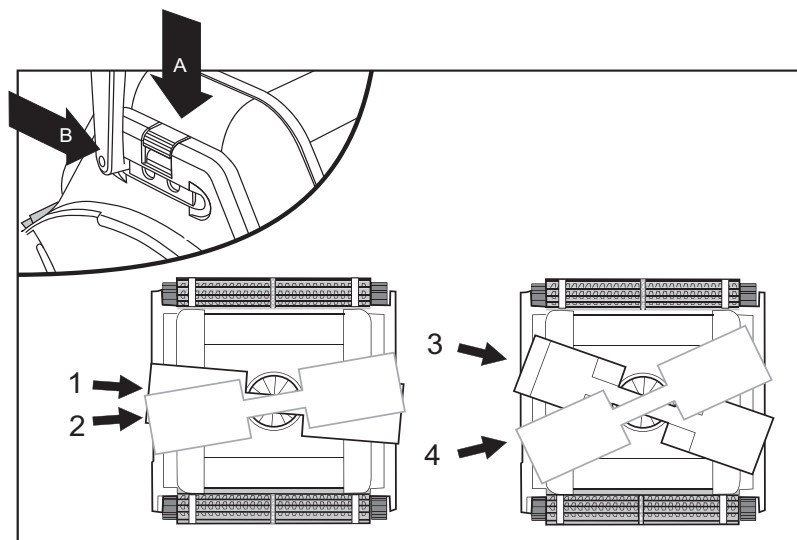

## 5.2. Putting the Pool Cleaner into the pool

If Wonder brush/ Wonder rings are dry, soak them in water until soft.

Shake the robot from side to side or turn it upside down to release trapped air.

Let it sink to the pool floor.

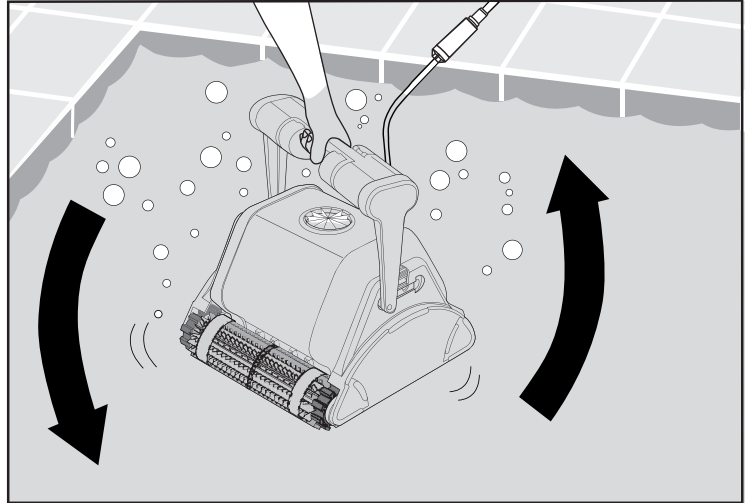

Turn the power supply ON

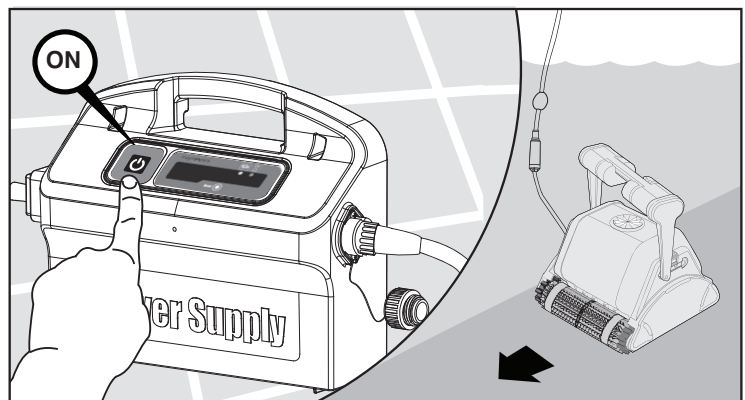

## 5.3. Removing the Pool Cleaner from the pool

The robot will perform automatic shut-off at the end of the cleaning cycle.

 Turn OFF and unplug the power supply

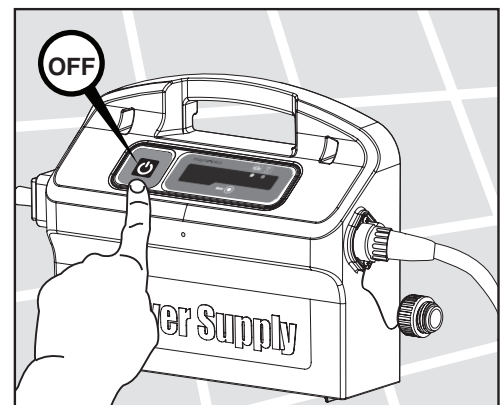

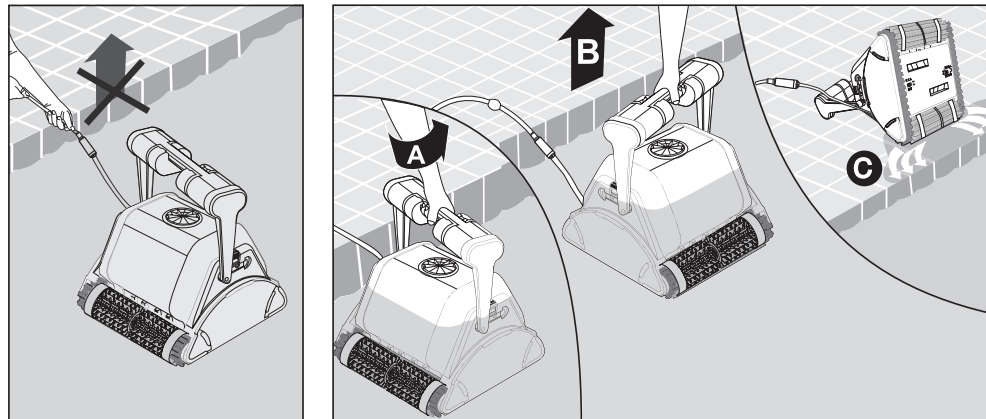

Using the floating cable, bring the Pool Cleaner to the pool's edge.

 DO NOT PULL THE POOL CLEANER FROM THE POOL USING THE CABLE

### 5.4. Maintenance

Clean the filter bag with a hose.  
 Periodically clean the brushes with a hose.  
 It is recommended to periodically wash the filter bag in a washing machine.  
 Use gentle cycle program.

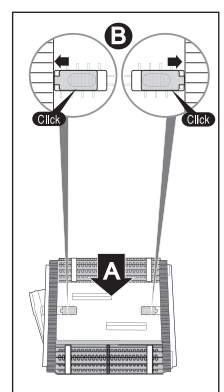
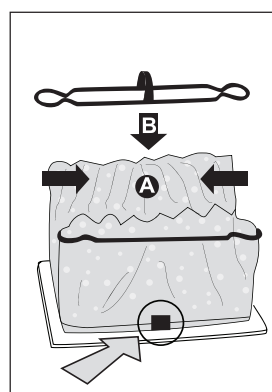
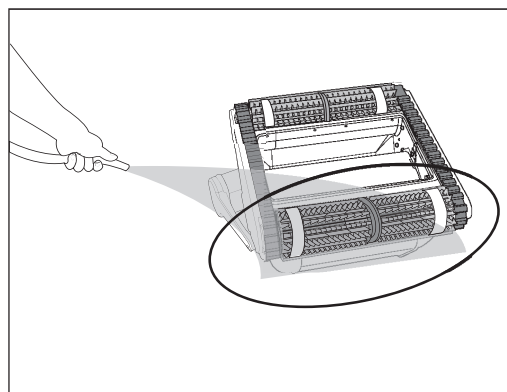
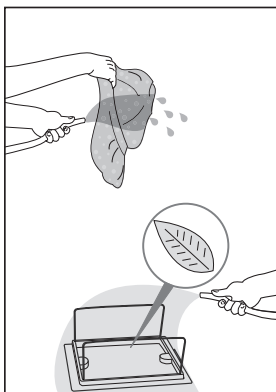
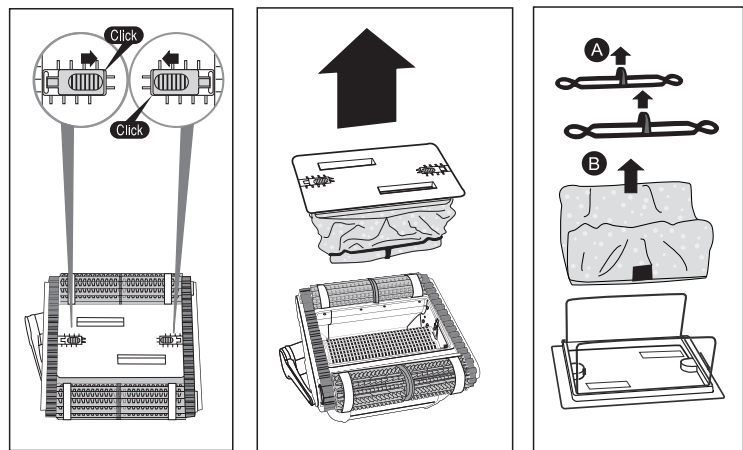



## Cleaning the impeller

 **Unplug the power supply**

If you notice debris trapped in the impeller open the impeller and remove the debris.

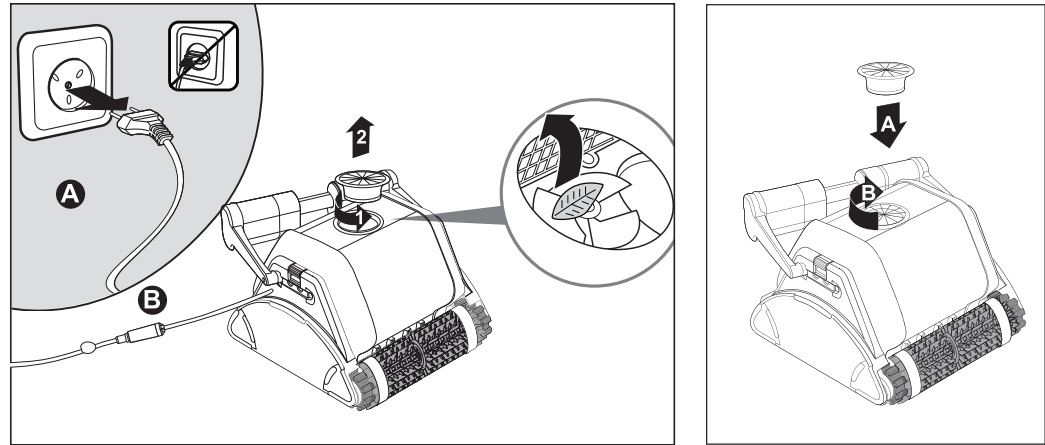

## Cable

To remove the kinks, stretch the cable out completely and let it sit for at least a day in the sun.

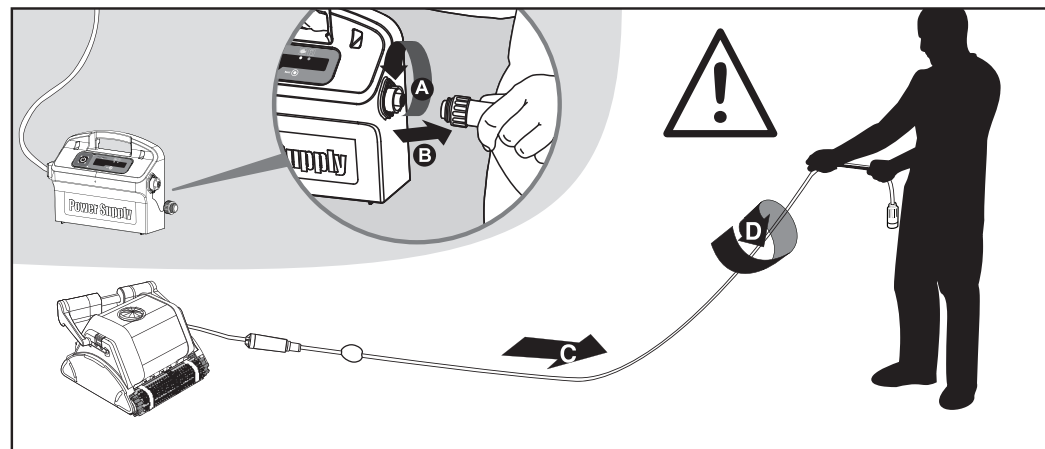

## 5.5. Off-season storage

If the pool cleaner will not be in use for an extended period, perform the following storage steps:

- Make sure that no water is left in the pool cleaner
- Thoroughly clean the filter bag and insert in place
- Roll up the cable so that it has no kinks and place on the Caddy
- Store the pool cleaner in a protected area either on its Caddy or simply upsidedown



## 6. POWER SUPPLY

Digital "Switch-Mode" Power Supply with full filter bag and delay indicator.

- Input - 100-250 AC Volts
- 50-60 Hertz
- 180 Watt
- Output - <30 VDC
- IP 54

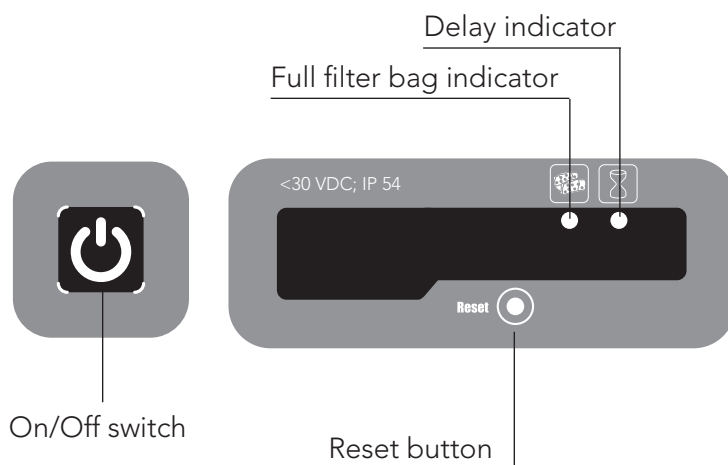
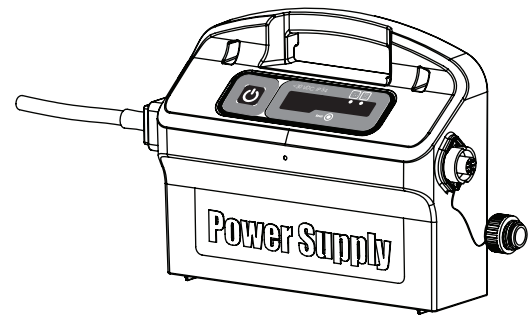

### Full filter bag indicator and Reset button

The power supply is equipped with a filter bag status indicator.

The red LED indicates two filter conditions.

- When blinking - The filter is partially blocked.
- When lighted - The filter is blocked and must be emptied and cleaned.

If the LED does not turn off after the filter bag had been emptied and cleaned, press the RESET button while the robot is working.



### Delay indicator

The power supply is equipped with a Delay indicator that indicates if the Delay option is activated (through the remote control unit).

## 7. REMOTE CONTROL UNIT

### The Control Panel

The remote control unit (RCU) offers two operation modes – Automatic mode and manual direction control mode.

In automatic mode, the cleaning parameters can be changed.

In manual direction mode, the robot's motion can be controlled manually.

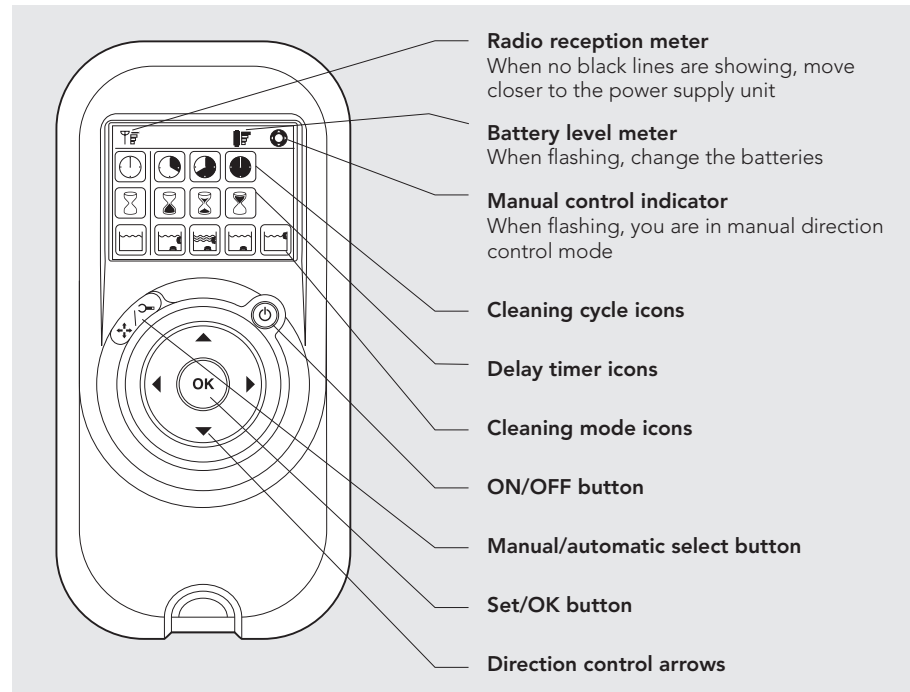

#### Manual Direction Control Mode

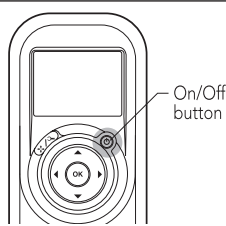

1. Press the On/Off button once. The remote control will start in manual direction control mode.
2. Use the direction control arrows (see right) to control the movement of the robot around the pool.

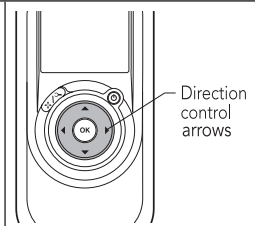

#### Exiting Manual Direction Control Mode and setting the Automatic Mode

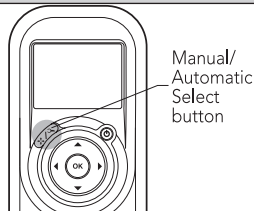



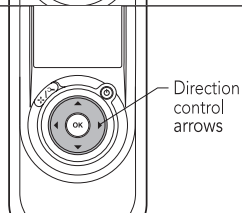
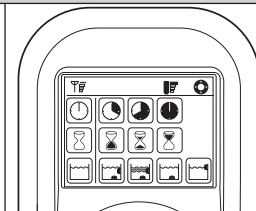



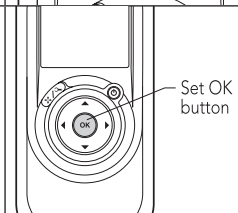





1. To exit the manual direction control mode, press the Manual/Automatic select button once only.
2. The digital screen will light up and three rows of function icons will be displayed in default mode.



1. To change the parameters press the up or down arrows.
2. To select the parameter settings use the right or left arrows. When you reach the required function press the Set/OK button.



Press the Manual/Automatic select button and then choose the desired parameters according to the following table:

 <p><b>Cleaning cycle indicator</b> This determines the length of the cleaning cycle.</p>	 <p><b>Fast</b> 4-hour cycle</p>	 <p><b>Efficient</b> 6-hour cycle for everyday use. <b>(Default setting)</b></p>	 <p><b>Extra</b> 8-hour cycle</p>	
 <p><b>Delay time indicator</b> This determines when the pool cleaner starts to work. Delaying allows the dirt to settle to the bottom of the pool.</p>	 <p><b>Immediate start</b> <b>(Default setting)</b></p>	 <p><b>One-hour delay</b></p>	 <p><b>Two-hour delay</b></p>	
 <p><b>Cleaning action indicator</b> Allowing you to choose from the following options.</p>	 <p><b>Standard</b> Floor and wall cleaning. <b>(Default setting)</b></p>	 <p><b>Ultra-clean</b> Stronger suction and slower movement. (floor and wall)</p>	 <p><b>Floor only</b> Cleans only the floor and the area where the floor and walls meet</p>	 <p><b>Walls only</b> Cleans walls and waterline only</p>

**Note:**

- After 2 minute if no button is pressed, the Remote Control Unit will shut-down and the Pool cleaner will continue to work in the previous settings.
- When the "Ultra-Clean" and "Walls Only" options finish their cycles, the Pool Cleaner will return to default settings.

**FR**

## **Dolphin PROX 2 Gyro nettoyeur de piscine** Instructions d'opération

### **Contents**

1. INTRODUCTION .....	12
2. SPECIFICATIONS .....	12
3. AVERTISSEMENTS ET PRECAUTIONS.....	12
3.1. Avertissements.....	12
3.2. Précautions.....	12
4. ELEMENTS DU NETTOYEUR DE PISCINE .....	13
5. UTILISATION DU NETTOYEUR DE PISCINE .....	14
5.1. Montage .....	14
5.2. Introduction du Nettoyeur dans la piscine .....	15
5.3. Retrait du Nettoyeur de la piscine .....	15
5.4. Entretien .....	16
5.5. Stockage hors saison .....	17
6. D'ALIMENTATION.....	18
7. LA TÉLÉCOMMANDE.....	19
CADDY DE MONTAGE.....	81

# Dolphin PROX 2 Gyro nettoyeur de piscine

## Instructions d'opération

### 1. INTRODUCTION

Merci d'avoir acheté ce Robot Nettoyeur de Piscine de chez Maytronics.

Nous sommes convaincus que votre Robot Nettoyeur de Piscine vous assurera un nettoyage crédible, convenable et rentable de votre piscine. Son filtrage fiable de toutes les piscines, son broyage actif et sa brosse grimpeuse sur toutes les surfaces permettent d'assurer l'hygiène maximale de votre piscine.

Les Robots Nettoyeurs de Piscine de Maytronics fournissent une technologie de nettoyage avancée, une performance de longue durée et une maintenance en toute simplicité. Vous et votre famille pourrez profiter en toute confiance d'une piscine entièrement propre.

### 2. SPECIFICATIONS

Protection du moteur: IP 68

Profondeur minimale: 0,80m/2,6 pieds

Profondeur maximale: 5m/16,4 pieds

### 3. AVERTISSEMENTS ET PRECAUTIONS

#### 3.1. Avertissements



- Utilisez uniquement le bloc d'alimentation électrique qui vous a été fourni à l'origine
- Assurez-vous que la prise électrique est protégée par un disjoncteur de fuite à la terre
- Eloignez le bloc d'alimentation des flaques d'eau
- Positionnez le bloc d'alimentation à au moins 3m du bord de la piscine
- N'entrez pas dans la piscine lorsque le Nettoyeur est en marche
- Débranchez l'alimentation électrique avant tout entretien du robot

#### 3.2. Précautions

Lorsqu'il n'est pas utilisé, entreposez le Nettoyeur de Piscine sur son Caddy dans un lieu ombragé.

N'utilisez le Nettoyeur de Piscine que lorsque les conditions de l'eau sont les suivantes:

Chlore	Max 4 ppm
pH	7,0 - 7,8
Température	6 – 34°C (43-93°F)
NaCl	Maximum = 5000 ppm

## 4. ELEMENTS DU NETTOYEUR DE PISCINE

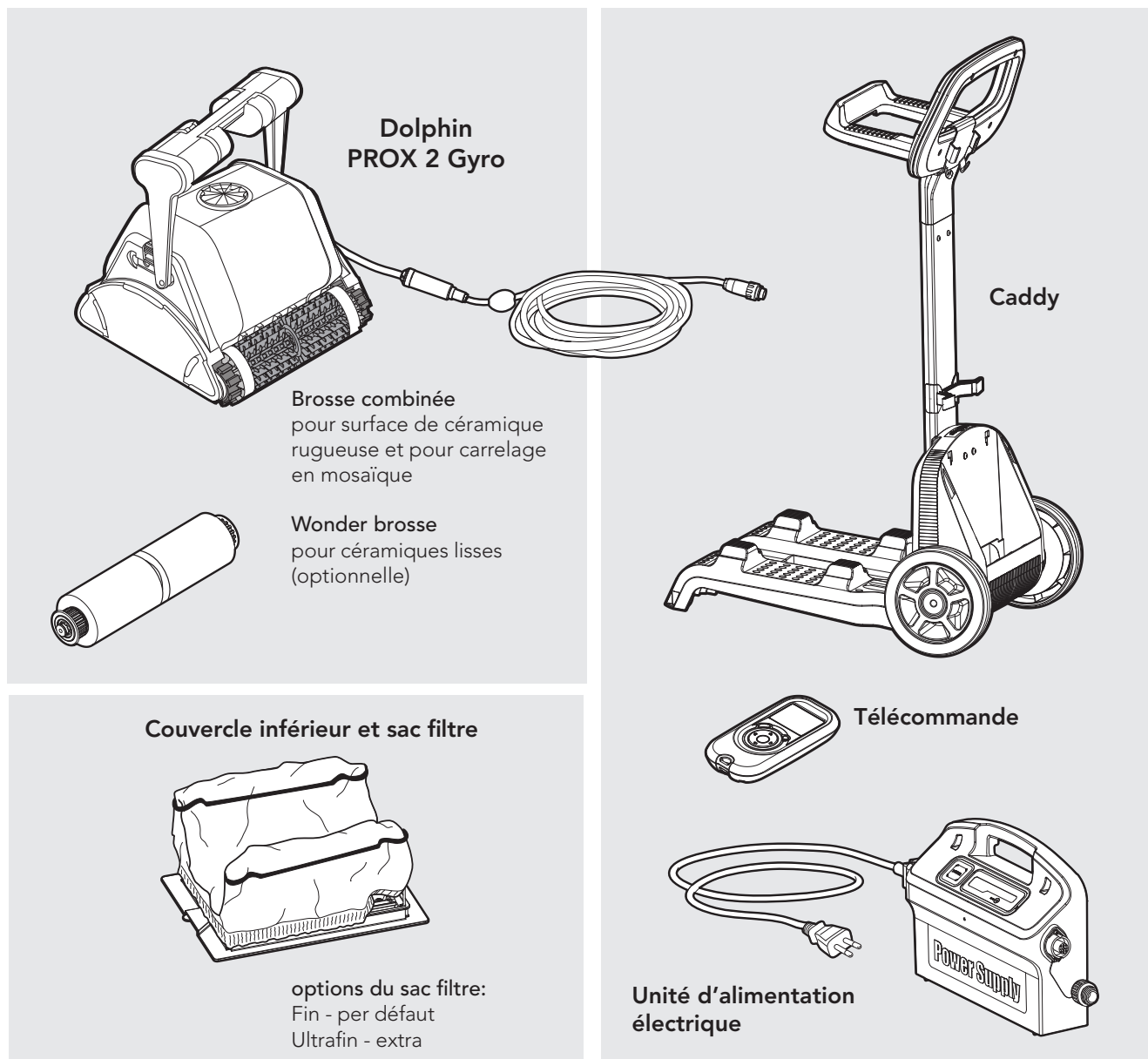

## 5. UTILISATION DU NETTOYEUR DE PISCINE

### 5.1. Montage

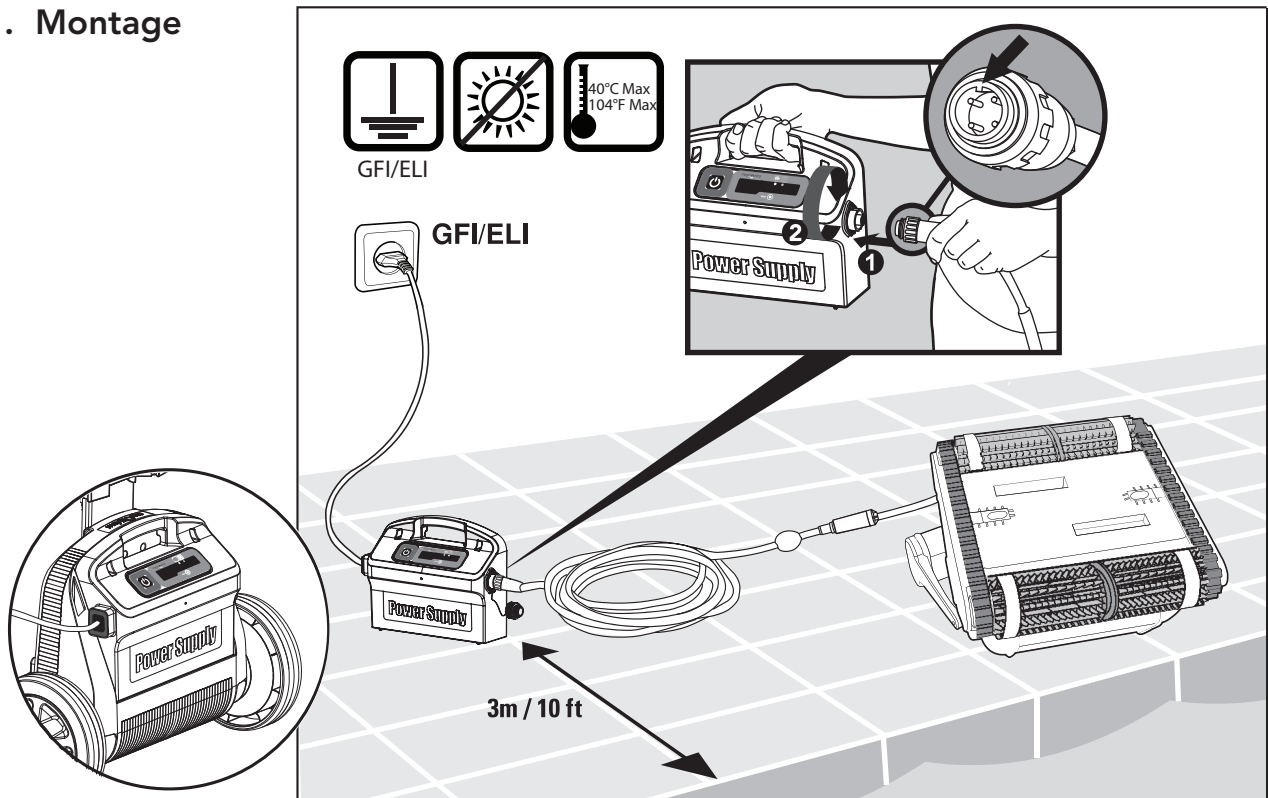

Modifiez la position diagonale de la poignée pour que le robot effectue les mouvements latéraux nécessaires au nettoyage de la bordure de l'eau.

Pour ajuster l'angle du manche:

- A. Appuyez vers le bas sur le loquet et maintenez-le en position.
- B. Placez le manche sur la position désirée et relâchez le loquet pour maintenir le manche en place.

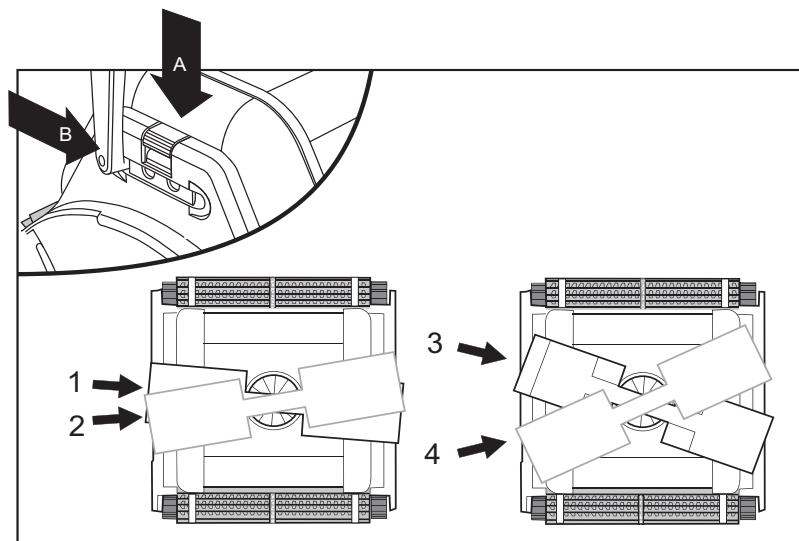



## 5.2. Introduction du Nettoyeur dans la piscine

Si la brosse "Wonder" ou les anneaux "Wonder" sont secs, les tremper dans l'eau jusqu'à ce qu'ils deviennent souples.

Secouez le robot sur les côtés ou de haut en bas pour libérer les bulles d'air.

Laissez-le couler vers le fond de la piscine.

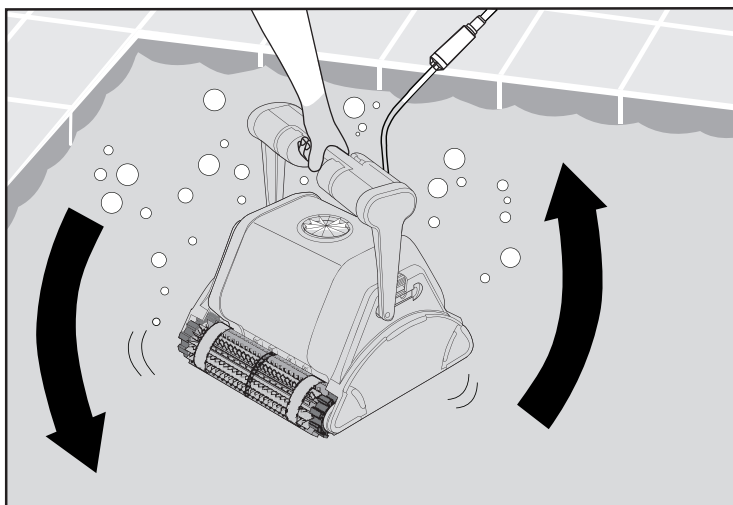

Mettez l'appareil sous tension (ON)

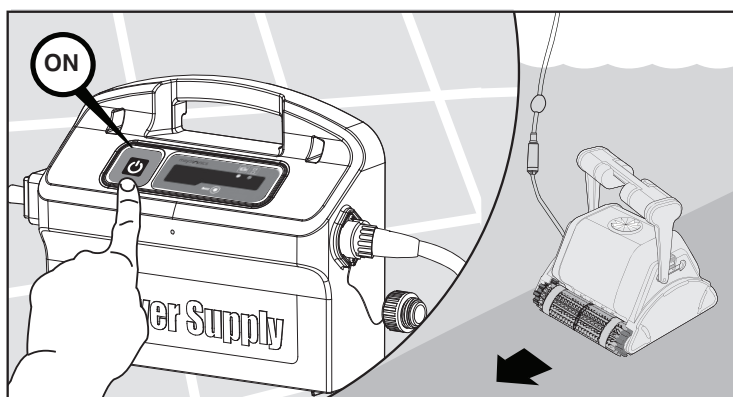

## 5.3. Retrait du Nettoyeur de la piscine

Le robot s'éteindra automatiquement à la fin du cycle de nettoyage.

 Coupez le courant (OFF) et débranchez le bloc d'alimentation

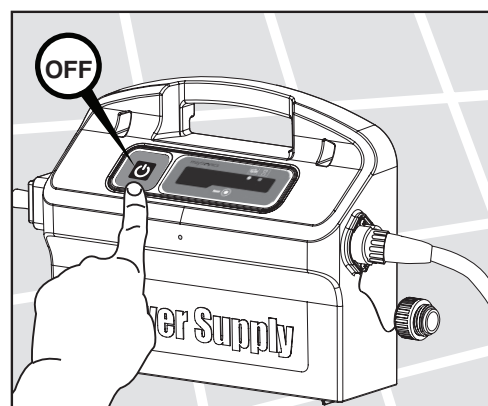

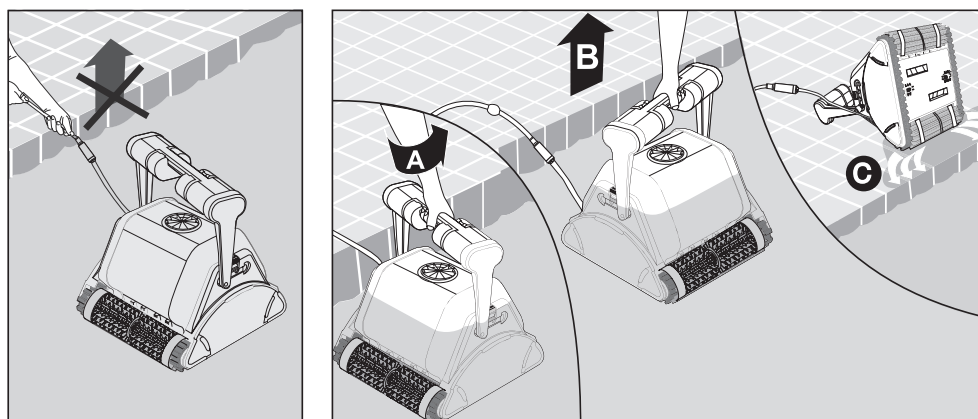

A l'aide du câble de flottaison, ramenez le Nettoyeur de Piscine au bord de la piscine.

 NE PAS RETIRER LE NETTOYEUR DE LA PISCINE EN TIRANT SUR LE CABLE

#### 5.4. Entretien

Nettoyez le sac de filtrage à l'aide d'un tuyau d'eau. De temps en temps, rincez les brosses à l'aide d'un tuyau d'eau. Il est recommandé de laver périodiquement le filtre dans la machine à laver. Utilisez le programme pour tissus délicats.

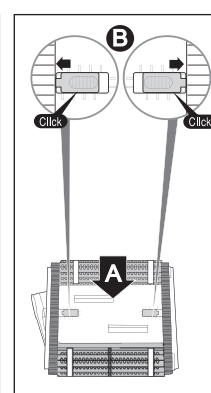
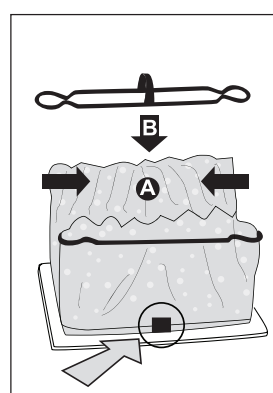
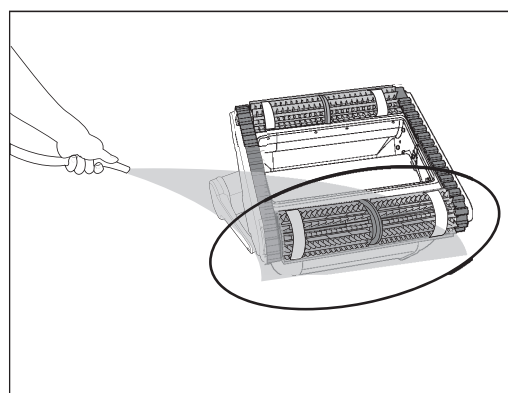
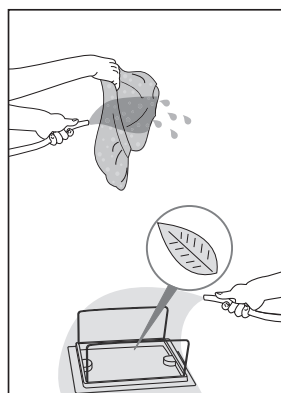
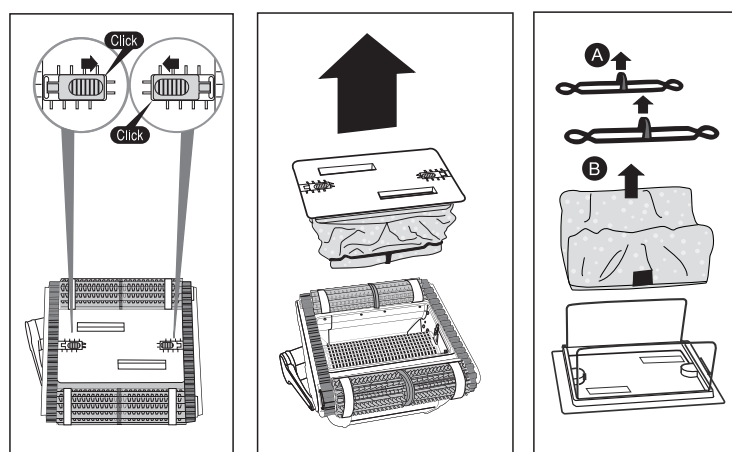

## Nettoyage de l'impulseur

 **Débranchez le bloc d'alimentation**

Si vous constatez l'existence de débris emprisonnés dans l'impulseur, ouvrez l'impulseur et retirez les débris.

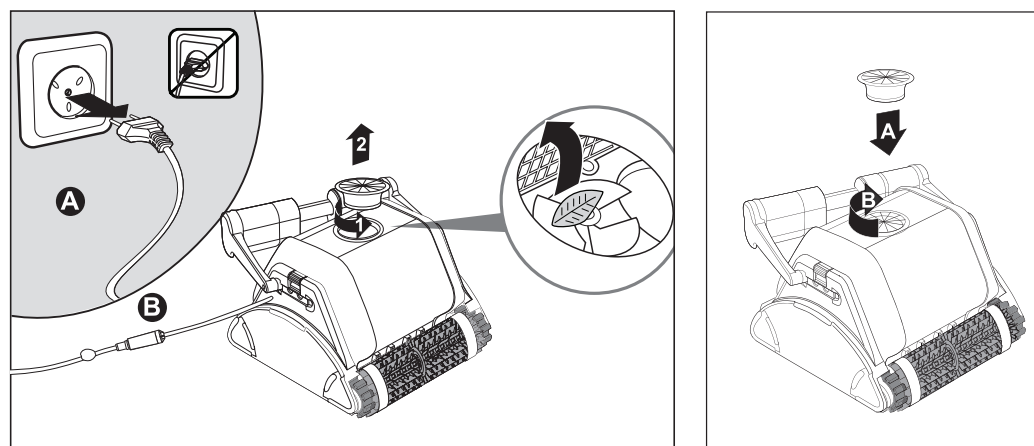

## Câble

Pour éliminer les plis, tendez le câble entièrement et laissez-le au soleil pendant au moins une journée.

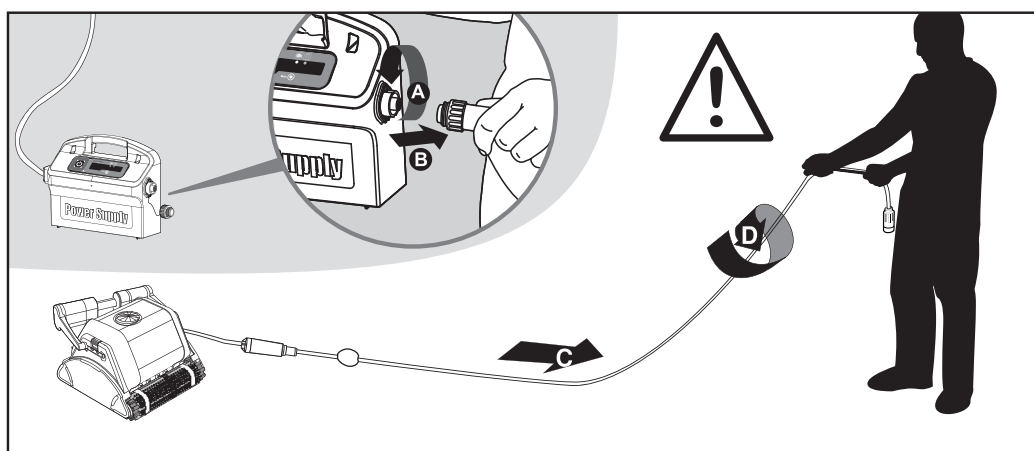

## 5.5. Stockage hors saison

Si le Nettoyeur de Piscine n'est pas utilisé pendant une période prolongée, veuillez l'entreposer de la manière suivante:

- Assurez-vous qu'il n'y a plus d'eau dans le Nettoyeur de Piscine
- Nettoyez à fond le sac de filtrage et remettez-le en place
- Rembobinez le câble sans y faire de plis et placez-le sur le Caddy
- Entrez le Nettoyeur de Piscine dans un endroit protégé soit sur son Caddy, soit simplement à l'envers

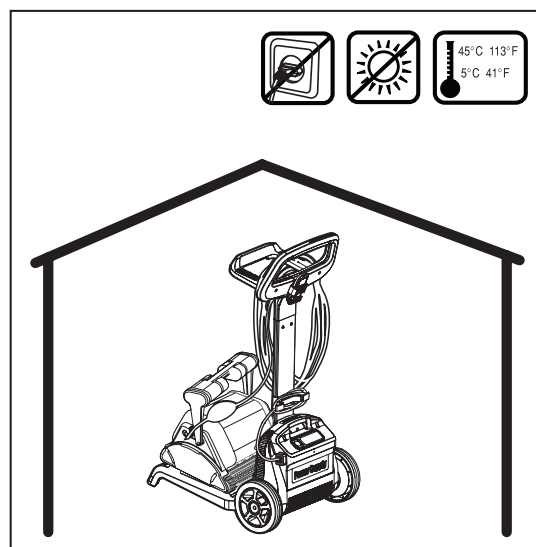

## 6. D'ALIMENTATION

Alimentation numérique avec « Mode Interrupteur » ("Switch-Mode") avec indicateur de sac filtre plein et de temporisation.

- Input - 100-250 AC Volts
- 50-60 Hertz
- 180 Watt
- Output - <30 VDC
- IP 54

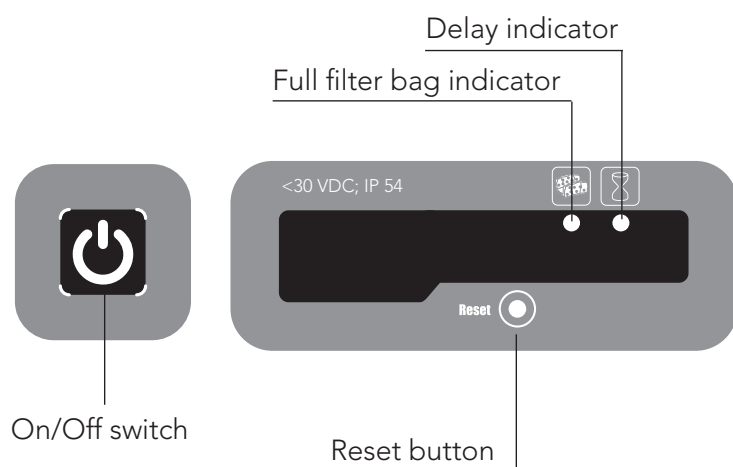
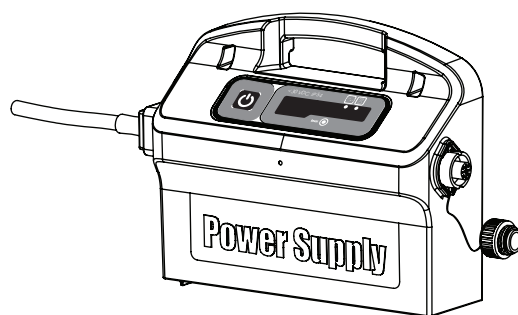

### Indicateur de sac filtre plein et touche de réinitialisation (Reset)

Le boîtier d'alimentation est équipé d'un voyant indiquant l'état du sac filtre.

Le voyant DEL rouge donne deux indications différentes selon le cas.

- S'il clignote – le sac filtre est partiellement plein.
- S'il est allumé en continu – le filtre est plein et doit être vidé, puis nettoyé.

Si le voyant ne s'éteint pas après que le sac filtre ait été vidé et nettoyé, appuyez sur la touche RESET pendant que le robot fonctionne.



### Indicateur de temporisation (Delay)

Le boîtier d'alimentation est équipé d'un voyant indiquant si l'option de temporisation a été activée ou non (à distance, par télécommande).

## 7. LA TÉLÉCOMMANDE

### Panneau de contrôle de la télécommande

La télécommande (RCU – Remote Control Unit) dispose de deux modes de fonctionnement – un mode de contrôle automatique et un mode de contrôle manuel de direction.

En mode automatique, tous les paramètres sont modifiables.

En mode manuel, la direction du robot nettoyeur de piscine peut être contrôlée manuellement.



#### Mode de contrôle manuel de la direction

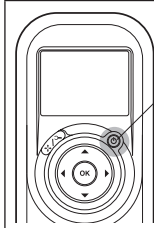

Bouton Marche/ Arrêt

1. Appuyez une fois sur le bouton Marche / Arrêt (ON/OFF) - La télécommande démarre en mode de contrôle manuel de la direction
2. Pour contrôler manuellement la direction du robot nettoyeur, utilisez les touches directionnelles selon le sens des flèches (voir schéma de droite)

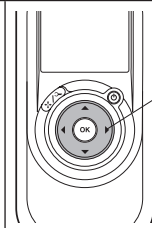

Flèches de contrôle de la direction

#### Sortie du Mode de Contrôle Manuel et Réglage du mode automatique

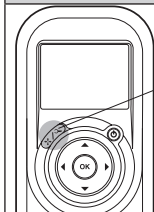

Sélecteur de mode Manuel/ Automatique

1. Pour quitter le mode de contrôle manuel de la direction, appuyez UNE SEULE fois sur le sélecteur de mode Manuel / Automatique
2. L'afficheur numérique s'allume et trois lignes de boutons fonctionnels s'affichent avec le paramétrage défini par défaut

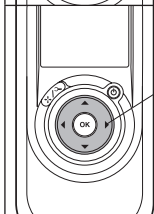
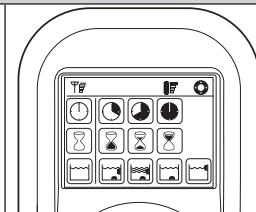





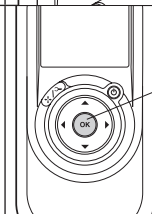







Flèches de contrôle de la direction

1. Modifiez les paramètres à l'aide des flèches orientées vers le haut ou vers le bas. Pour sélectionner les divers réglages, utilisez les flèches orientées vers la droite ou vers la gauche
2. Dès que vous atteignez la fonction voulue, il vous suffit d'appuyer sur le bouton Réglage / Validation (Set/OK)



Bouton Réglage/ Validation

Appuyez tout d'abord sur la touche Manuel Automatique pour sélectionner le mode, ensuite réalisez les réglages selon le tableau ci-dessous:

 <p><b>Indicateur de cycle de nettoyage</b> Cette touche détermine la durée du cycle de nettoyage. La télécommande vous permet de choisir parmi les options suivantes.</p>	 <p><b>Rapide</b> Cycle de 4 h</p>	 <p><b>Efficace (Réglage par défaut)</b> Cycle de 6 h. pour une utilisation quotidien.</p>	 <p><b>Extra</b> Cycle de 8 h</p>	
 <p><b>Indicateur de temporisation</b> Cette touche détermine le moment de déclenchement du cycle par l'appareil. Un début de cycle différé (temporisé) permet de laisser les impuretés se déposer au fond de la piscine.</p>	 <p><b>Début de cycle immédiat (Réglage par défaut)</b></p>	 <p><b>Temporisation d'une heure</b></p>	 <p><b>Temporisation de deux heures</b></p>	
 <p><b>Indicateur du mode de nettoyage</b> Cette touche vous permet de choisir parmi les options suivantes.</p>	 <p><b>Standard</b> Nettoyage du sol et des parois. <b>(Réglage par défaut)</b></p>	 <p><b>Ultra-propre</b> Aspiration plus puissante et mouvement plus lent. (Sol et parois)</p>	 <p><b>Sol uniquement</b> Nettoie seulement le sol et les plinthes.</p>	 <p><b>Parois seulement</b> Nettoie seulement les parois et la bordure de l'eau.</p>

**Remarque:**

- Au bout de 2 minutes d'inactivité des touches, la télécommande s'éteint et le robot nettoyeur poursuit le cycle entamé selon le paramétrage en cours.
- A la fin des cycles "Ultra-propre" et "Parois seulement", le robot nettoyeur récupère les réglages définis par défaut.

**IT**

## **Dolphin PROX 2 Gyro pulitore per piscina** Istruzioni per l'uso

---

### **Contents**

1. INTRODUZIONE.....	22
2. SCHEDA TECNICA.....	22
3. AVVERTENZE E PRECAUZIONI .....	22
3.1. Avvertenze.....	22
3.2. Precauciones .....	22
4. PARTI DI RICAMBIO PER PULITORE .....	23
5. UTILIZZAZIONE DEL PULITORE .....	24
5.1. Installazione.....	24
5.2. Immergete il pulitore nella piscina.....	25
5.3. Estrazione del pulitore dalla piscina.....	25
5.4. Manutenzione .....	26
5.5. Manutenzione fuori stagione.....	27
6. ALIMENTAZIONE.....	28
7. TELECOMANDO.....	29
CADDY DI MONTAGGIO.....	81

# Dolphin PROX 2 Gyro pulitore per piscina

## Instruzioni per l'uso

### 1. INTRODUZIONE

Vi ringraziamo per aver acquistato un pulitore per piscina robotico della Maytronics.

Con il pulitore robotico della Maytronics la pulizia della vostra piscina sarà garantita, comoda ed economica. Il filtraggio garantito in tutte le condizioni, lo spazzolamento vigoroso e la capacità delle spazzole di scalare tutti i tipi di superficie massimizzano l'igiene della piscina.

Il pulitore per piscina robotico della Maytronics fornisce una tecnologia di pulizia avanzata, prestazioni di lunga durata e facile manutenzione. Potrete nuotare con la vostra famiglia senza pensieri, certi che la vostra piscina è veramente pulita.

### 2. SCHEDA TECNICA

Protezione del motore: Codice IP 68

Profondità minima: 0.80 m/2.6 ft

Profondità massima: 5 m/16.4 ft

### 3. AVVERTENZE E PRECAUZIONI

#### 3.1. Avvertenze



- Usate soltanto l'alimentatore elettrico originariamente fornito
- Assicuratevi che la presa elettrica sia protetta da un interruttore differenziale o da un interruttore termico
- Non tenete l'alimentatore elettrico in acqua
- Ponete l'alimentatore elettrico almeno 3 m/10 ft dall'orlo della piscina
- Non entrate in piscina mentre il pulitore è in funzione
- Staccate l'alimentatore elettrico prima di effettuare la manutenzione

#### 3.2. Precauciones

Quando non in uso tenete il pulitore all'ombra sul suo Caddy.

Usate il pulitore soltanto quando l'acqua è nelle seguenti condizioni:

Cloro	Máx. 4 ppm
pH	7,0 - 7,8
Temperatura	6 - 34 °C
NaCl	Máximo = 5000 ppm



## 4. PARTI DI RICAMBIO PER PULITORE



**Dolphin  
PROX 2 Gyro**

Spazzola combinata  
per rivestimenti in ceramica  
ruvida e a mosaico

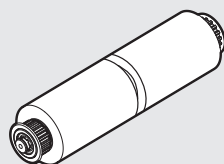

Spazzola "Wonder Brush"  
per rivestimenti in ceramica  
liscia  
(Opzionale)

**Coperchio inferiore e sacchetto filtro**

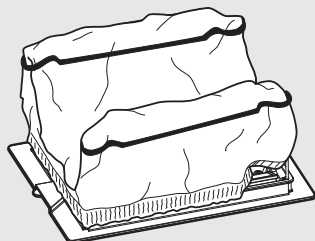

Opzioni del sacchetto filtro:  
Fine - impostazione predefinita  
Ultra fine - supplementare

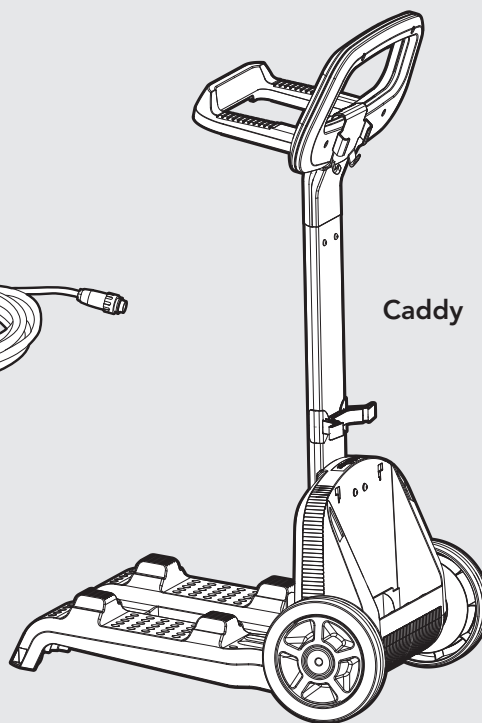

**Caddy**



**Telecomando**

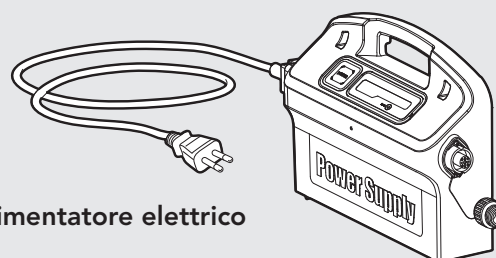

**Alimentatore elettrico**

## 5. UTILIZZAZIONE DEL PULITORE

### 5.1. Installazione

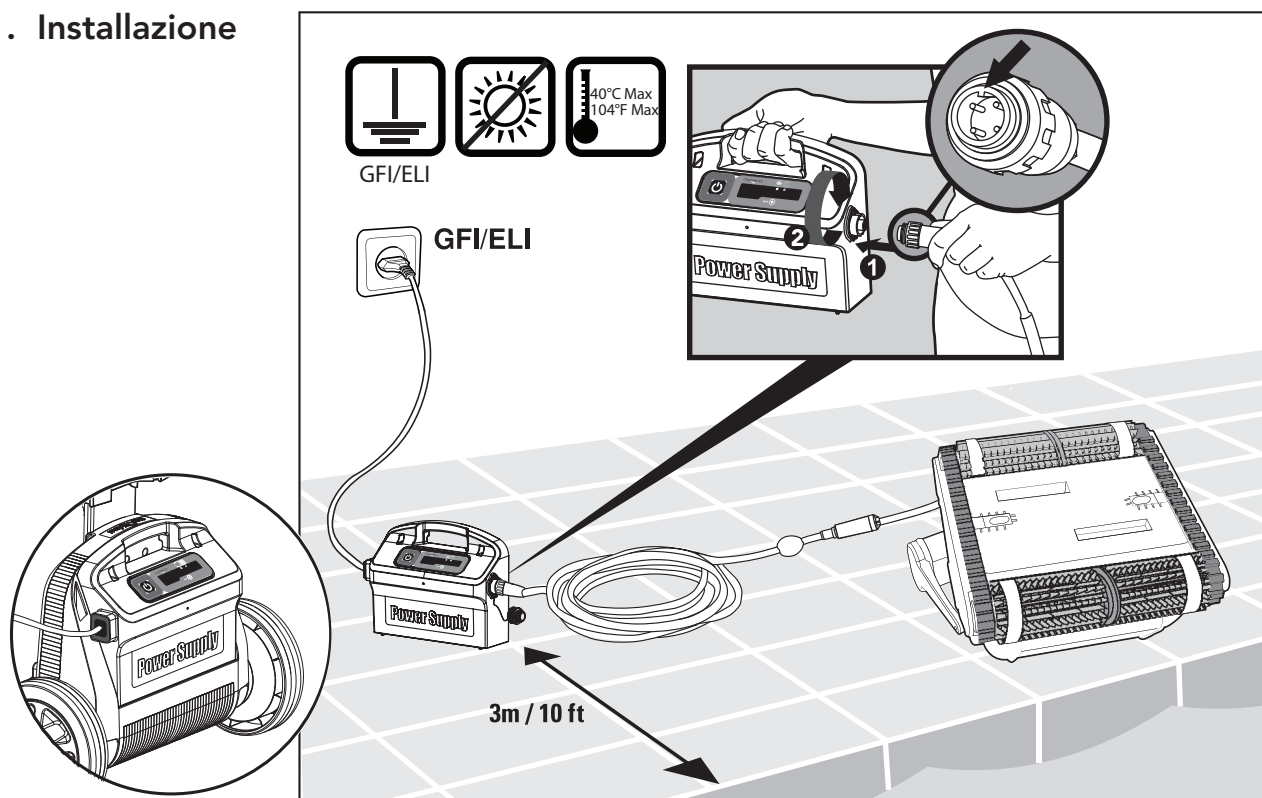

Cambiare la posizione diagonale della maniglia per il movimento di lato alla linea di galleggiamento.

Per regolare l'angolo dell'impugnatura:

- A. Premere il fermo in basso e trattenercelo.
- B. Spostare l'impugnatura alla posizione desiderata e rilasciare il fermo per trattenere l'impugnatura in posizione.

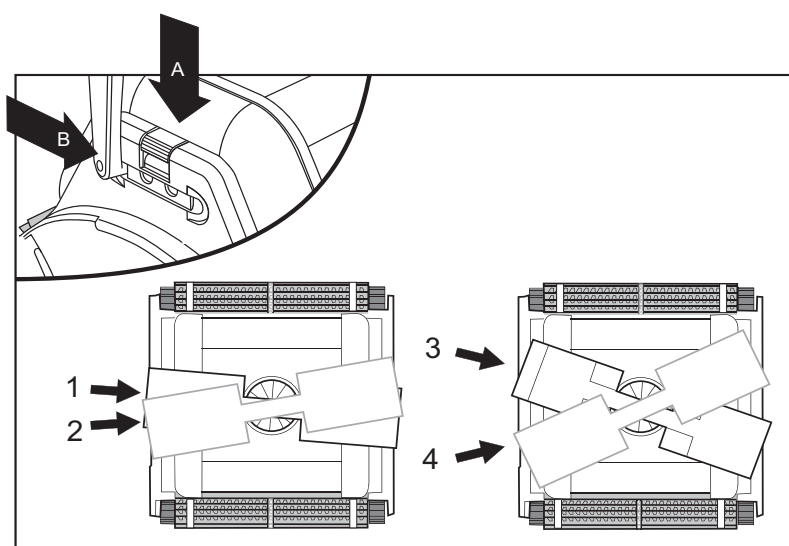

## 5.2. Immergete il pulitore nella piscina

Se la spazzola Wonder/anelli Wonder sono asciutti immergeteli in acqua fino a farli ammorbidire.

Scuotere il robot di da un lato all'altro o girarlo a testa in giù per liberarne l'aria imprigionata. Lasciate che si posi sul fondo della piscina.

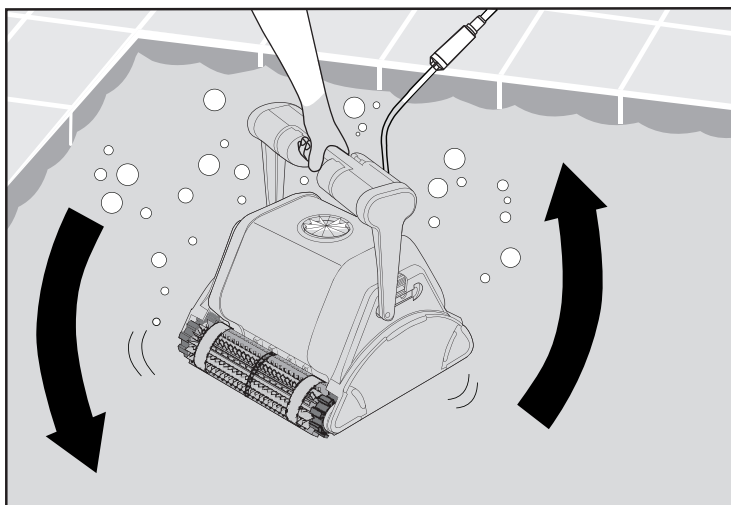

Inserite il trasformatore

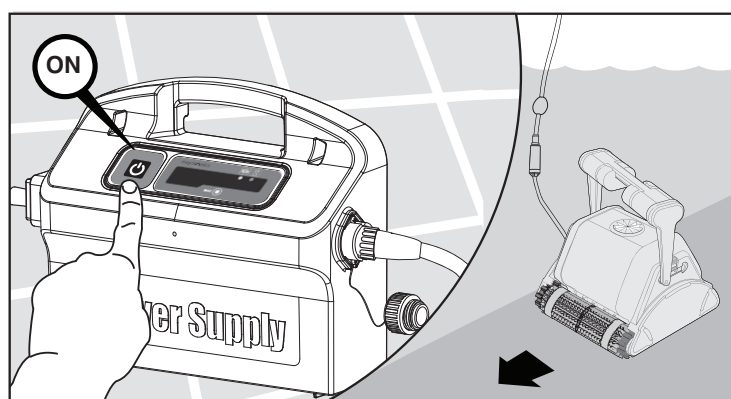

## 5.3. Estrazione del pulitore dalla piscina

Il robot si disattiverà automaticamente alla fine del ciclo di pulizia.

 Spegnete e staccate il trasformatore.

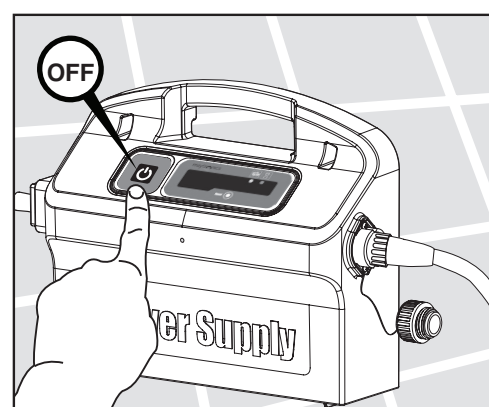

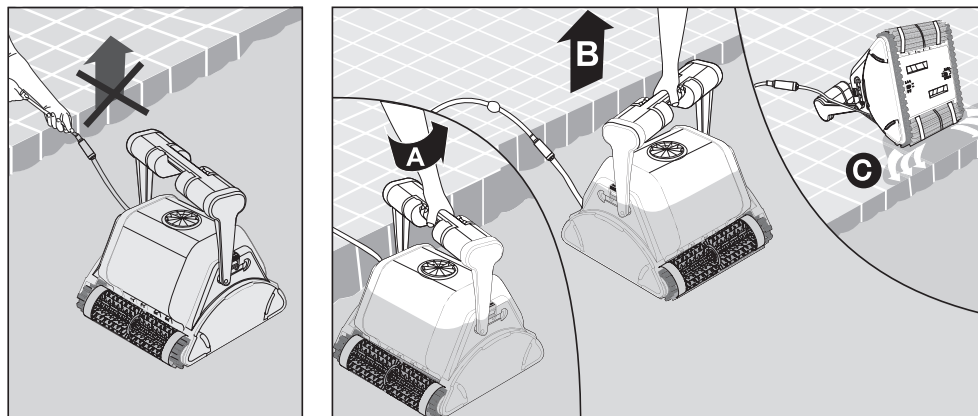

Usando il cavo galleggiante, tirate il pulitore verso il bordo della piscina.

**!** NON ESTRAETE IL PULITORE DALLA PISCINA TIRANDO IL CAVO

#### 5.4. Manutenzione

Sciagate il sacchetto filtrante sotto l'acqua corrente. Periodicamente pulite le spazzole sotto l'acqua corrente. È raccomandabile lavare periodicamente il sacchetto-filtro in una macchina lavatrice. Selezionare un programma di lavaggio per materiali sintetici.

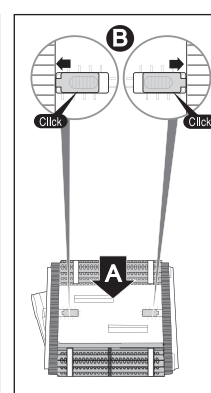
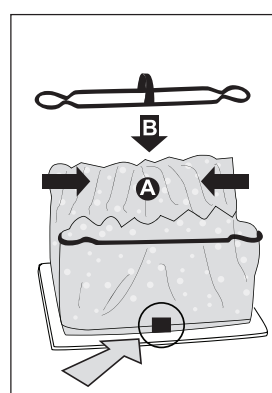
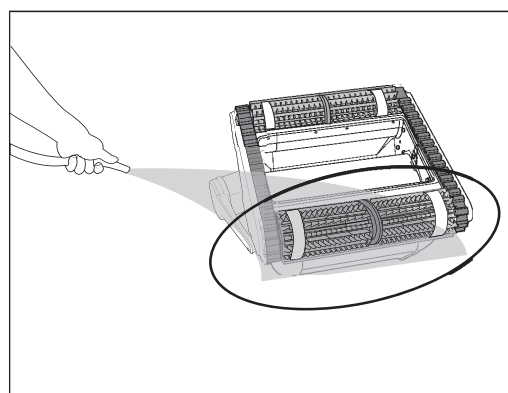
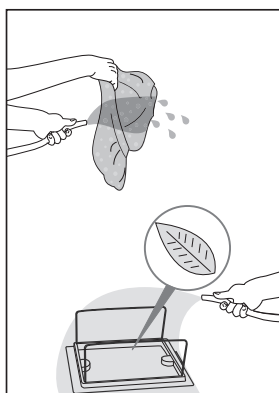
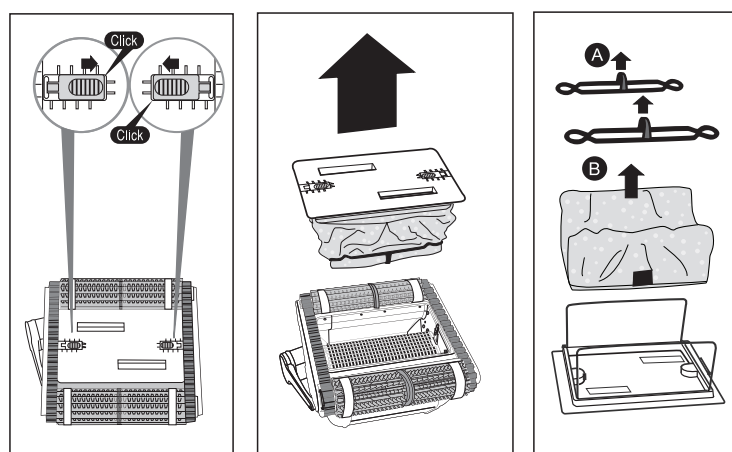

## Pulizia della girante

 **Staccate il trasformatore**

Se la girante è ostruita da detriti, aprirla e rimuoverli.

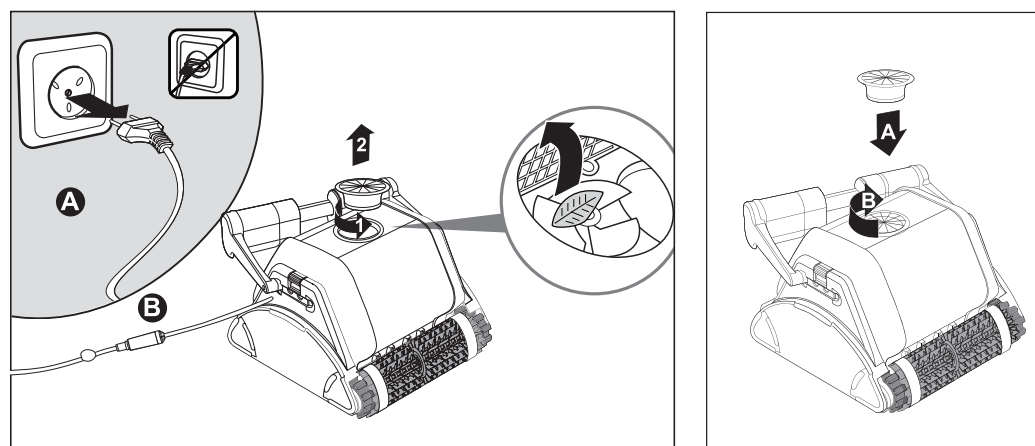

## Cavo

Per eliminare l'attorcigliamento, stendere tutto il cavo e lasciarlo al sole per almeno una giornata.

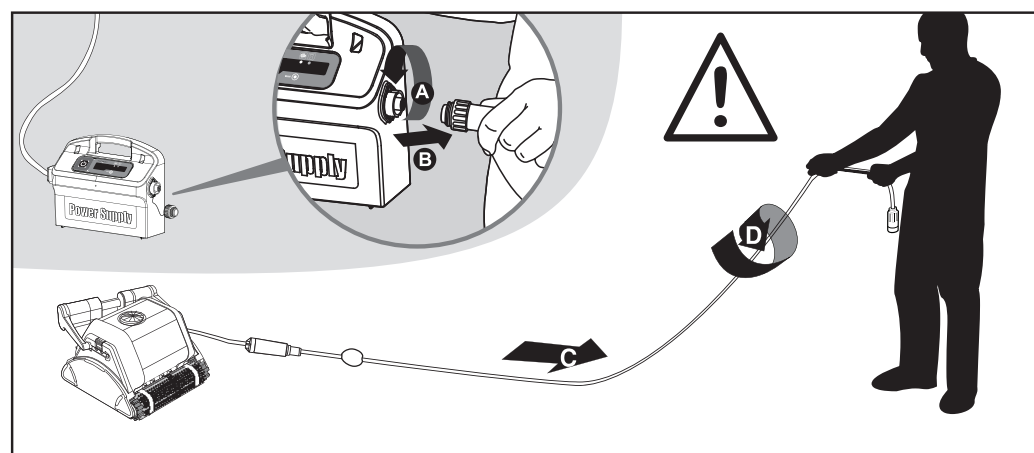

## 5.5. Manutenzione fuori stagione

Se il pulitore non verrà utilizzato per un lungo periodo, prima di metterlo via, eseguite le operazioni seguenti:

- Assicuratevi che non vi sia più acqua all'interno del pulitore
- Pulite accuratamente e rimettete a posto il sacchetto filtrante
- Arrotolate il cavo in modo che non sia attorcigliato e mettetelo nel Caddy
- Mettete il pulitore al riparo o sul suo Caddy o semplicemente capovolto



## 6. ALIMENTAZIONE

Alimentatore digitale "Switch-Mode" con indicatore di sacco del filtro pieno e di ritardo.

- Input - 100-250 AC Volts
- 50-60 Hertz
- 180 Watt
- Output - <30 VDC
- IP 54

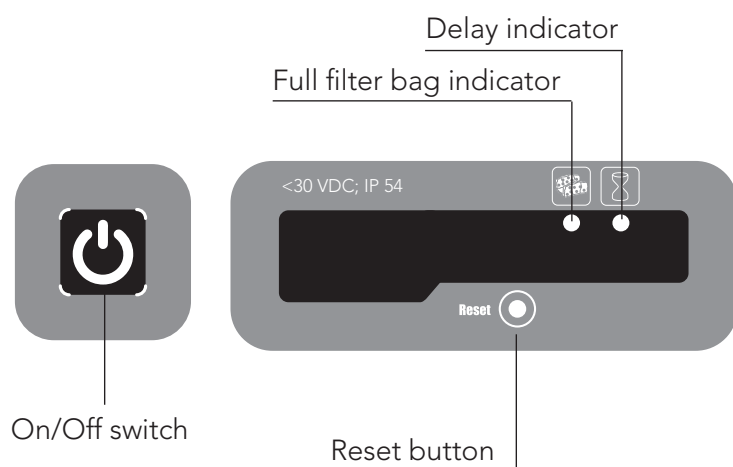
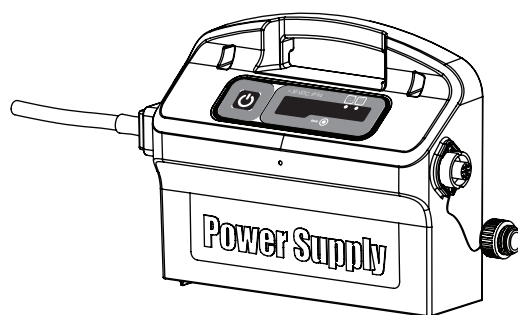

### Indicatore di filtro pieno e tasto Reset

L'alimentatore è equipaggiato di indicatore di stato del sacchetto filtro.

Il LED rosso indica due situazioni del filtro.

- Lampeggiante – il sacchetto filtro è parzialmente bloccato.
- Acceso – il filtro è bloccato e deve essere vuotato e pulito.

Se il LED non si spegne dopo che il sacchetto filtro è stato vuotato e pulito, premere il tasto RESET, mentre il robot è operante.



### Indicatore di ritardo (Delay)

L'alimentatore è equipaggiato con un indicatore di Ritardo che indica se l'opzione di ritardo è attivata (tramite il telecomando).

## 7. TELECOMANDO

### Il pannello di controllo del telecomando

Il telecomando offre due modalità operative – la modalità automatica e la modalità di controllo manuale della direzione.

In modalità automatica, tutti i parametri relativi alla pulizia possono essere modificati.

In modalità direzione manuale, la direzione del robot di pulizia della piscina può essere controllata manualmente.

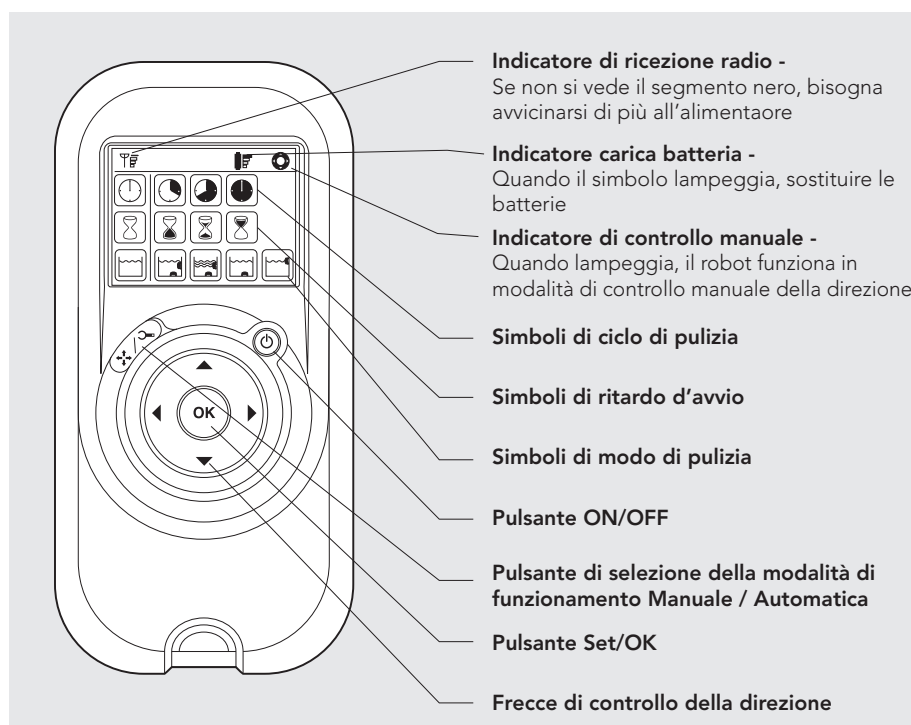

#### Modalità di controllo manuale della direzione

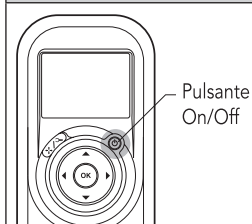

1. Premere una volta il pulsante ON/OFF - Il telecomando avvia il robot in modalità di controllo manuale della direzione
2. Per controllare manualmente la direzione del robot, utilizzare le frecce di controllo della direzione (come illustrato nella figura a destra)

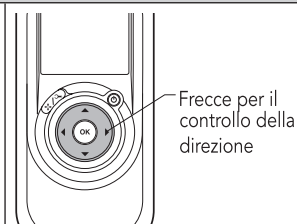

#### Impostazione della modalità automatica di funzionamento al posto della modalità di controllo manuale della direzione

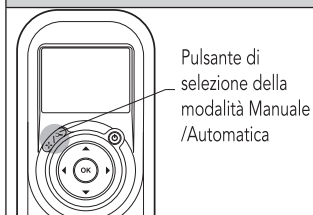



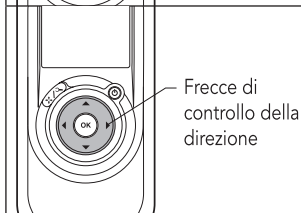
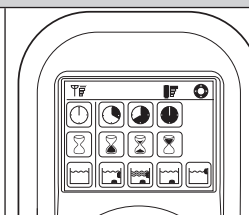



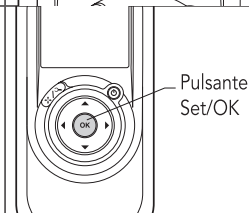





1. Per uscire dalla modalità di controllo manuale della direzione, premere UNA SOLA VOLTA il pulsante di selezione della modalità Manuale / Automatica
2. Il quadrante digitale si illumina ed appaiono tre file di simboli in modalità predefinita



1. Per modificare i parametri premere le frecce in su o in giù. Per scegliere le impostazioni dei parametri usare le frecce a destra ed a sinistra.
2. Una volta raggiunta la funzione desiderata, premere il pulsante Set/OK



Premere prima il pulsante di selezione della modalità Manuale / Automatica, poi eseguire le impostazioni secondo la tabella che segue:

 <p><b>Indicatore del ciclo di pulizia</b> Questo determina la durata del ciclo di pulizia. Il telecomando consente di scegliere tra le opzioni seguenti.</p>	 <p><b>Veloce</b> Ciclo della durata di 4 ore</p>	 <p><b>Efficiente (Impostazione predefinita)</b> Ciclo della durata di 6 ore per uso quotidiano</p>	 <p><b>Extra</b> Ciclo della durata di 8 ore</p>	
 <p><b>Indicatore del tempo in cui l'avvio è posticipato</b> Questo stabilisce quando il robot per la pulizia della piscina viene attivato. L'avvio posticipato consente allo sporco di depositarsi sul fondo della piscina.</p>	 <p><b>Avvio immediato (Impostazione predefinita)</b></p>	 <p><b>Un'ora di ritardo</b></p>	 <p><b>Due ore di ritardo</b></p>	
 <p><b>Indicatore del modo di pulizia</b> Consente di scegliere tra i seguenti modi di pulizia.</p>	 <p><b>Standard (Impostazione predefinita)</b> Pulizia di fondale e pareti</p>	 <p><b>Ultra-pulito</b> Maggiore suzione e movimento più lento. (fondale e pareti)</p>	 <p><b>Solo fondale</b> Pulizia di soli fondale ed angoli</p>	 <p><b>Solo pareti</b> Pulizia di sole pareti e linea di livello dell'acqua</p>

**Nota:**

- Dopo 2 minuti, se non viene premuto alcun pulsante, il telecomando si spegne ed il robot continua a funzionare in base alle impostazioni selezionate in precedenza.
- Quando termina il ciclo nei modi di pulizia "Ultra-pulito" e "Solo pareti", il robot ritorna alle impostazioni predefinite.



**ES**

# Dolphin PROX 2 Gyro robot limpiador de piscinas

## Instrucciones de manejo

---

### Índice

1. INTRODUCCIÓN.....	32
2. ESPECIFICACIONES .....	32
3. ADVERTENCIAS Y PRECAUCIONES.....	32
3.1. Advertencias.....	32
3.2. Precauciones .....	32
4. PIEZAS DEL LIMPIADOR DE PISCINAS .....	33
5. USO DEL LIMPIADOR DE PISCINAS.....	34
5.1. Preparación .....	34
5.2. Inmersión del limpiador en la piscina.....	35
5.3. Extracción del limpiador de la piscina.....	35
5.4. Mantenimiento.....	36
5.5. Almacenamiento fuera de temporada.....	37
6. FUENTE DE ALIMENTACIÓN .....	38
7. LA UNIDAD DE CONTROL REMOTO (RCU).....	39
CADDY DE MONTAJE.....	81

# Dolphin PROX 2 Gyro robot limpiador de piscinas

## Instrucciones de manejo

### 1. INTRODUCCIÓN

Gracias por comprar el robot limpiador de piscinas de Maytronics.

Estamos seguros de que con el robot limpiador de piscinas de Maytronics, usted podrá limpiar su piscina de una forma cómoda, segura y rentable. La fiabilidad del filtrado, independientemente del estado de la piscina, el cepillado activo y la habilidad para trepar en todo tipo de superficies aumentan al máximo la higiene de la piscina.

Los robots limpiadores de piscinas de Maytronics emplean avanzadas tecnologías de limpieza, tienen un rendimiento duradero y su mantenimiento es sencillo. Usted y su familia podrán disfrutar de un baño con total confianza de que su piscina está completamente limpia.

### 2. ESPECIFICACIONES

Protección del motor: IP 68

Profundidad mínima: 0,80 m/2,60 ft

Profundidad máxima: 5,00 m/16,4 ft

### 3. ADVERTENCIAS Y PRECAUCIONES



#### 3.1. Advertencias

- Use únicamente la fuente de alimentación original suministrada
- Asegúrese de que la toma de corriente está protegida por un interruptor diferencial o por un interruptor de fuga a tierra
- Mantenga la fuente de alimentación alejada del agua
- Coloque la fuente de alimentación a una distancia de al menos 3 m desde el borde de la piscina
- No entre a la piscina mientras el limpiador de piscina esté en funcionamiento
- Desenchufe la fuente de alimentación antes de realizar el mantenimiento

#### 3.2. Precauciones

Cuando no use el limpiador de piscinas, colóquelo en el Caddy, en un lugar a la sombra.

Use el limpiador de piscinas únicamente bajo las siguientes condiciones del agua:

Cloro	Máx. 4 ppm
pH	7,0 - 7,8
Temperatura	6 - 34 °C (43 -93°F)
NaCl	Máximo = 5000 ppm

#### 4. PIEZAS DEL LIMPIADOR DE PISCINAS

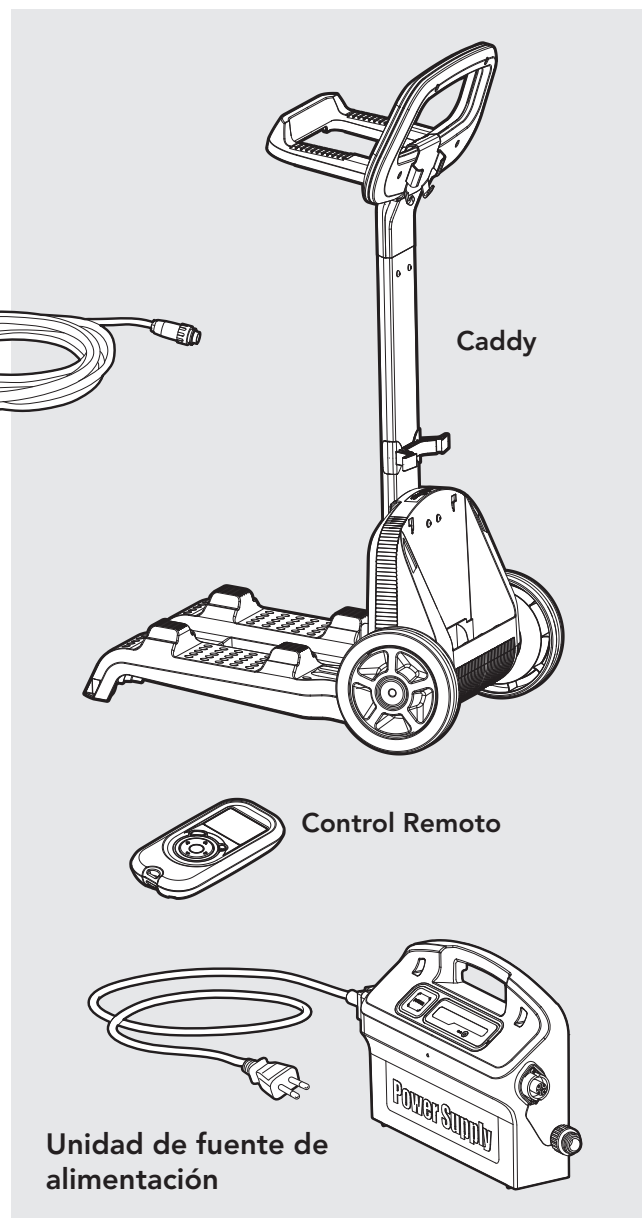

## 5. USO DEL LIMPIADOR DE PISCINAS

### 5.1. Preparación

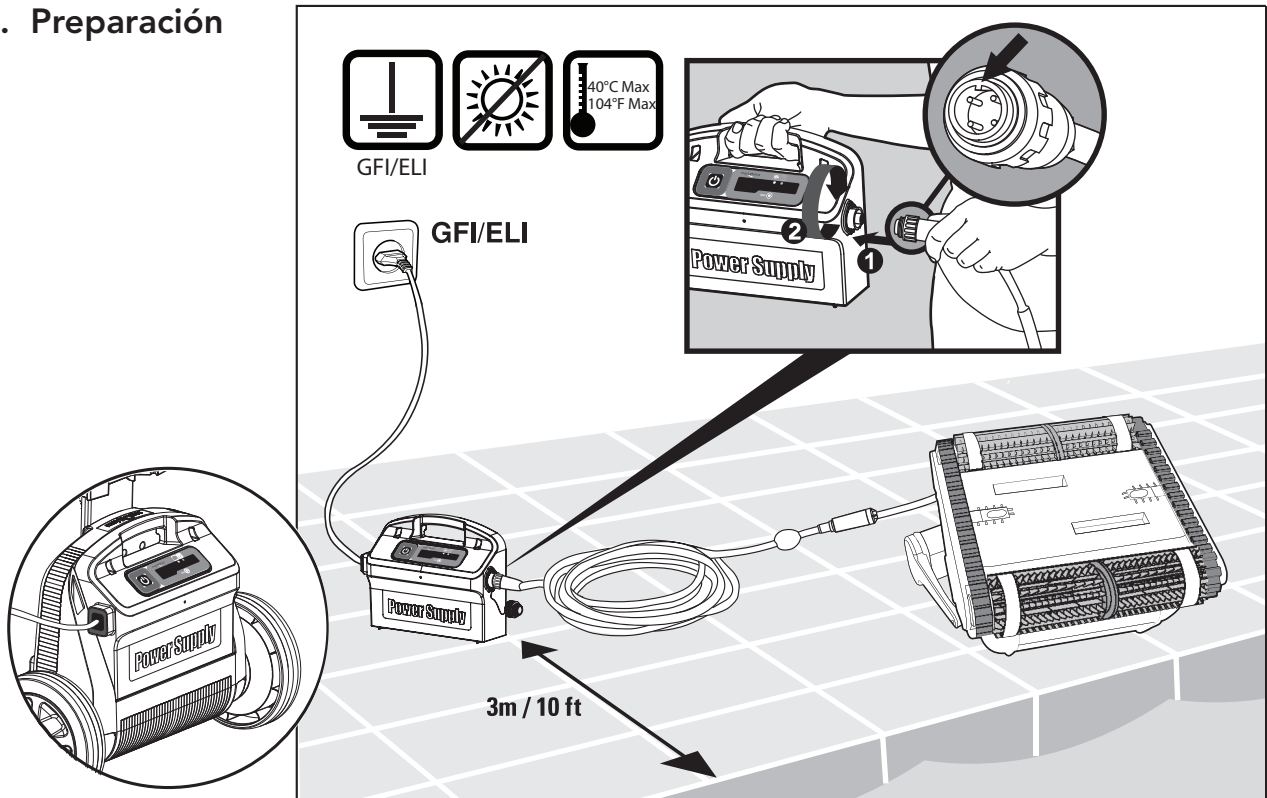

Cambie la posición diagonal de la manija para movimiento lateral de la línea de fluctuación.

Para ajustar el ángulo del mango:

- A. Presione el pestillo hacia abajo y manténgalo en esa posición.
- B. Mueva la palanca a la posición deseada y suelte el pestillo para sujetar el mango en su lugar.

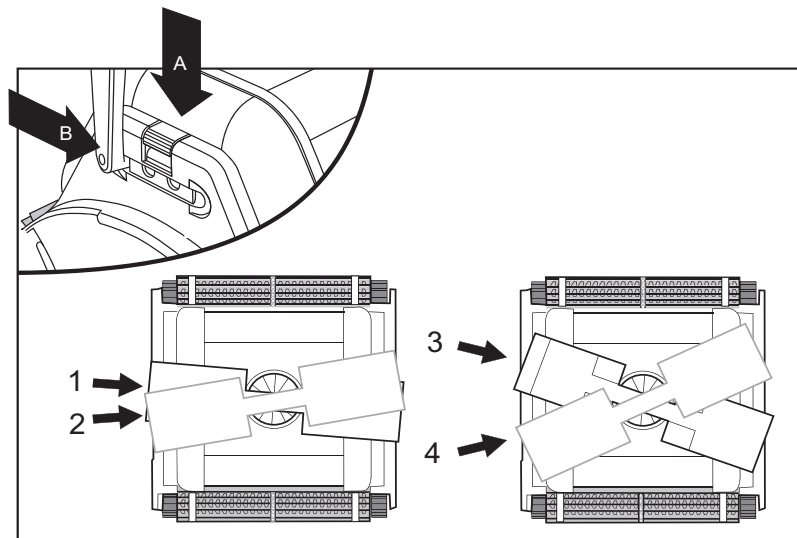

## 5.2. Inmersión del limpiador en la piscina

Si el cepillo Wonder/los anillos Wonder están secos, sumérgalos en agua hasta que estén suaves.

Sacuda el robot de lado a lado o póngalo boca arriba para soltar el aire retenido.

Deje que se hunda hasta el fondo de la piscina.

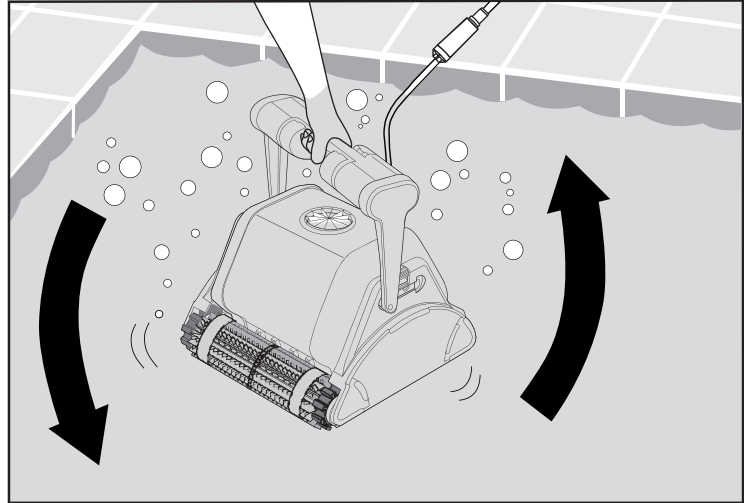

Encienda la fuente de alimentación

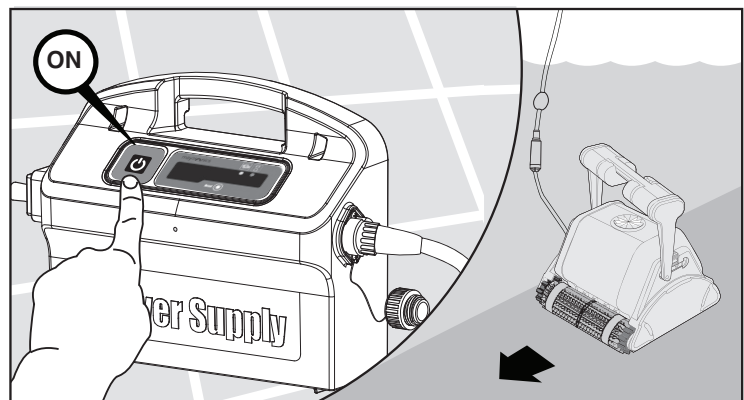

## 5.3. Extracción del limpiador de la piscina

El robot efectuará el apagado automático al término del ciclo de limpieza.

 Apague y desenchufe la fuente de alimentación.

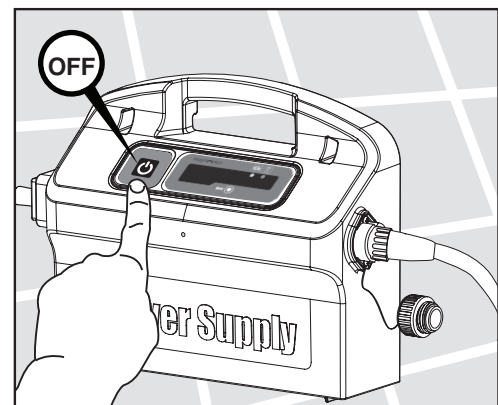

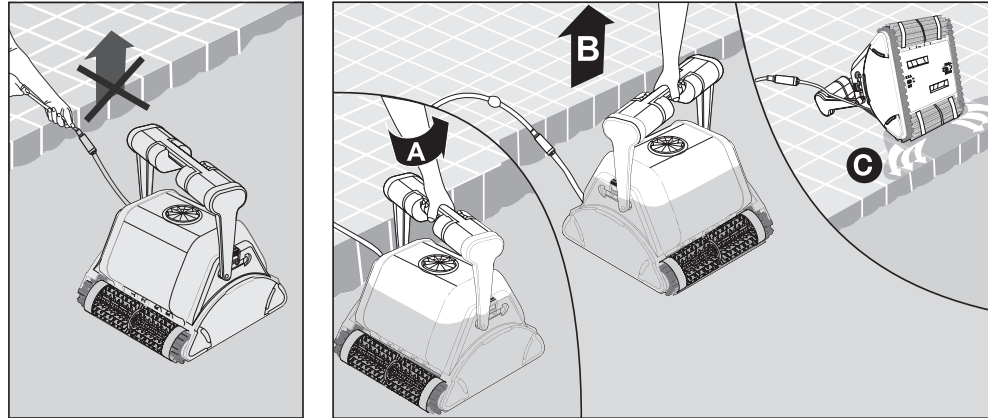

Use el cable flotador para acercar el limpiador hasta el borde de la piscina.



NO USE EL CABLE PARA SACAR EL LIMPIADOR DE LA PISCINA

### 5.4. Mantenimiento

Limpie la bolsa del filtro con una manguera. Limpie los cepillos periódicamente con una manguera. Se recomienda lavar periódicamente la bolsa del filtro en una máquina lavadora. Utilice el programa para el lavado suave.

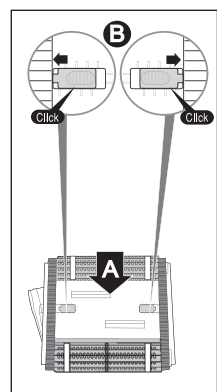
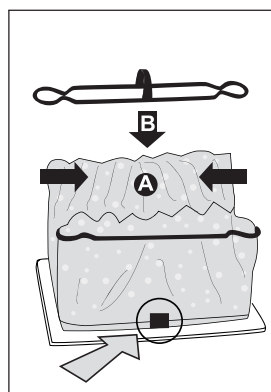
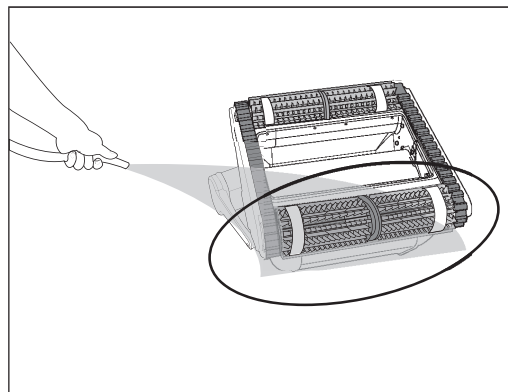
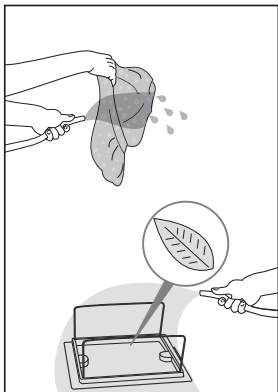
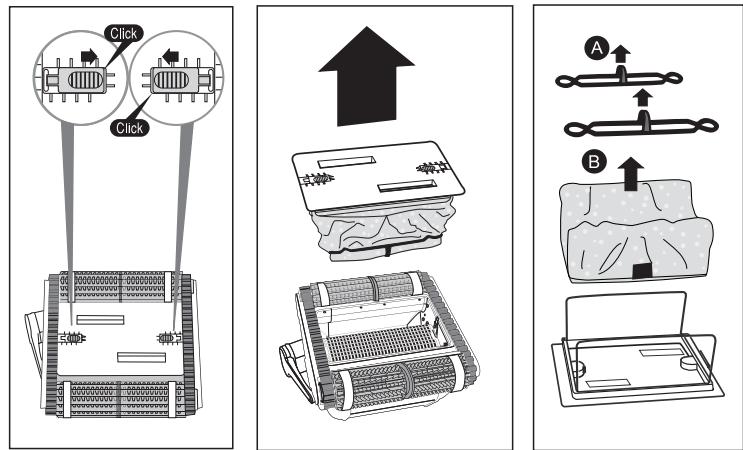

## Limpieza de la turbina

**⚠ Desenchufe la fuente de alimentación**

Si nota que hay suciedad atrapada en la turbina, abra la cubierta y extraiga la suciedad.

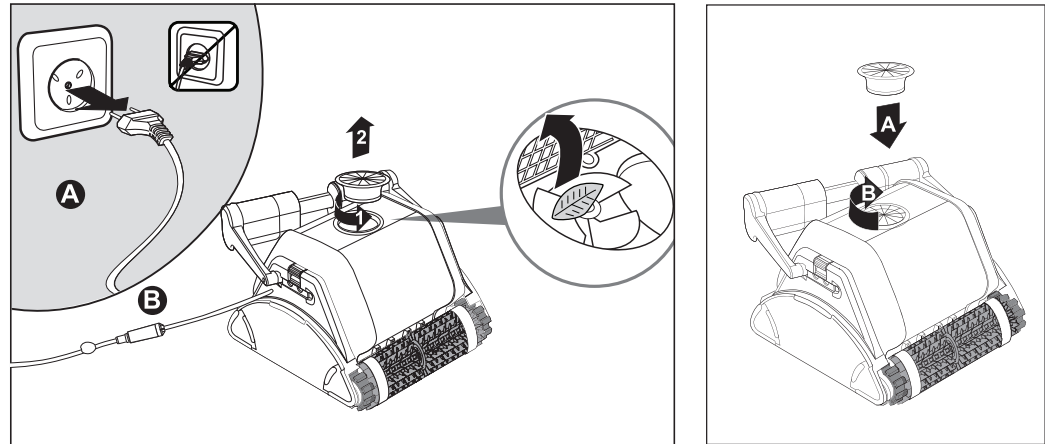

## Cable

Para eliminar las torceduras, estire completamente el cable y déjelo reposar al sol durante al menos un día.

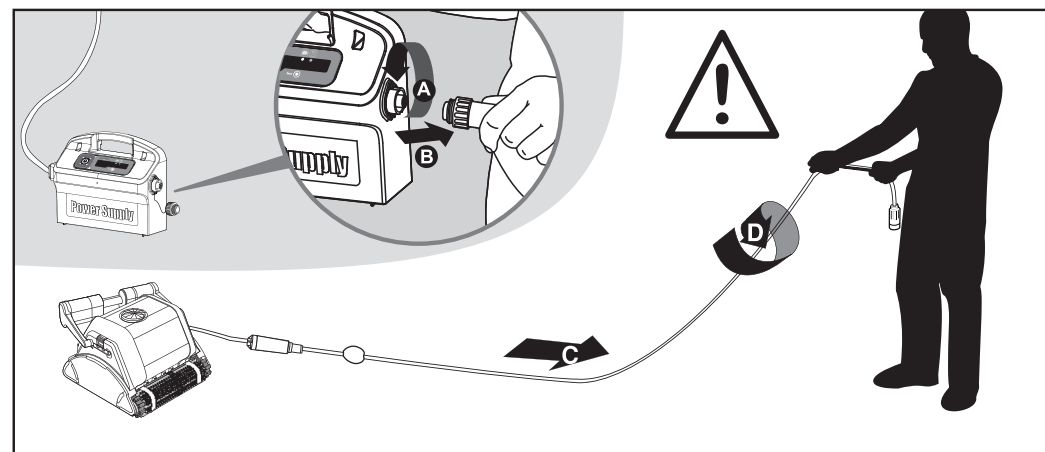

## 5.5. Almacenamiento fuera de temporada

Si no va a usar el limpiador de piscinas durante un período prolongado, siga los pasos de almacenamiento que se indican a continuación:

- Asegúrese de que no hay agua en el limpiador de piscinas
- Limpie a fondo la bolsa del filtro e introdúzcala en su sitio
- Enrolle el cable de modo que no tenga torceduras y colóquelo en el Caddy
- Almacene el limpiador de piscinas en un lugar protegido, bien en su Caddy, o simplemente boca abajo

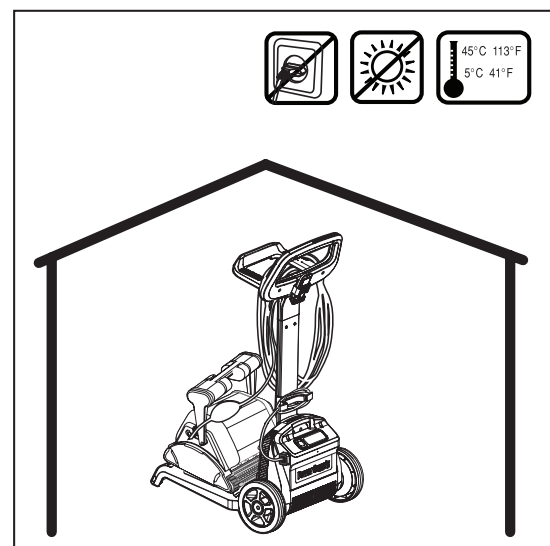

## 6. FUENTE DE ALIMENTACIÓN

Fuente de Alimentación con Modo de Cambio Digital, con bolsa de filtro llena y indicador de retraso.

- Input - 100-250 AC Volts
- 50-60 Hertz
- 180 Watt
- Output - <30 VDC
- IP 54

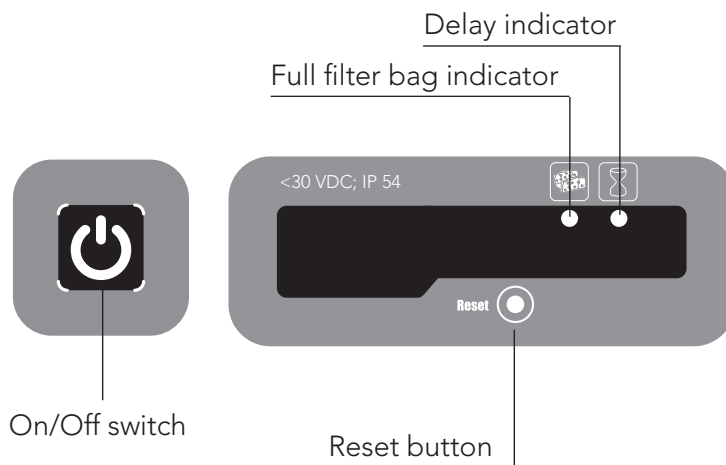
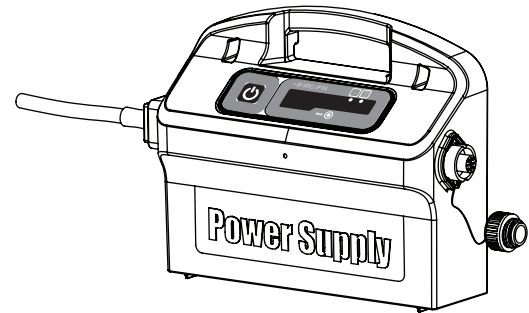

### Indicador de bolsa de filtro llena y botón Reset

La fuente de alimentación está equipada con un indicador del estado de la bolsa de filtro.

El LED rojo indica dos condiciones de filtro.

- Cuando parpadea – la bolsa de filtro está parcialmente bloqueada.
- Cuando está iluminado – el filtro está bloqueado y debe ser vaciado y limpiado.

Si el LED no se apaga después de que la bolsa del filtro ha sido vaciada y limpiada, pulse el botón Reset mientras el robot esté trabajando.



### Indicador de retardo (Delay)

La fuente de alimentación está equipada con un indicador de retardo que indica si la opción de retardo está activada (a través de la unidad de control remoto).



## 7. LA UNIDAD DE CONTROL REMOTO (RCU)

La RCU ofrece dos modos de operación – Modo Automático y Modo Manual de Control de dirección.

En el modo Automático, todos los parámetros de limpieza pueden ser modificados.

En el modo Manual de dirección, la dirección del Limpiador de Piscinas puede ser controlada manualmente.

### El Panel de Control de la Unidad de Control Remoto

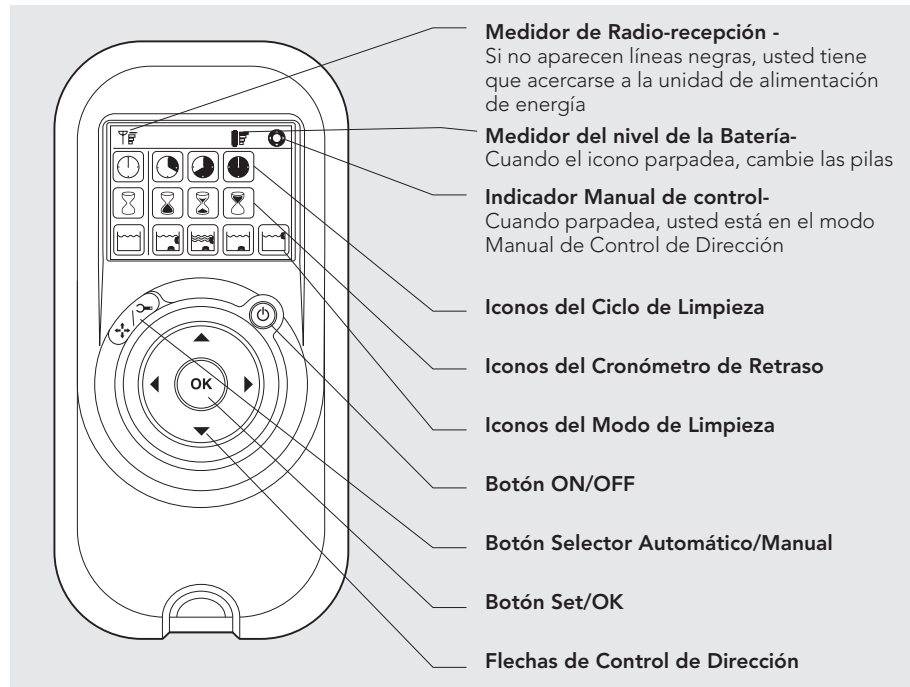

#### Modo Manual de Control de Dirección

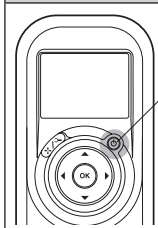

Botón On/Off

1. Presione el botón ON/OFF una vez -La RCU iniciará en el modo Manual de Control de Dirección
2. Para controlar manualmente la dirección del limpiador, use las flechas de control de dirección (ver a la derecha)

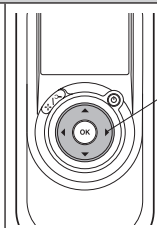

Flechas de Control de Dirección

#### Salir del Modo Manual de Control de Dirección y configurar el Modo Automático

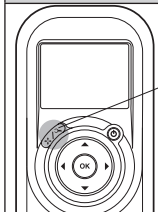

Botón de Selección Manual/Automático

1. Para salir del modo Manual de Control de Dirección, presione el botón de Selección Manual/Automático apenas UNA VEZ
2. La pantalla digital se iluminará y tres líneas de iconos de función aparecerán en el modo predeterminado

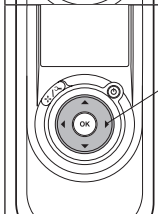
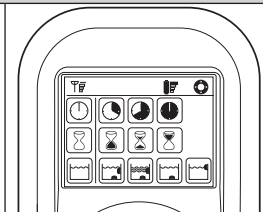





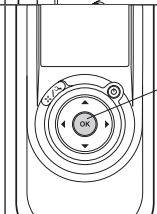







Flechas de Control de Dirección

1. Para modificar los parámetros presione las flechas para arriba y para abajo. Para elegir la configuración de los parámetros, use las flechas de la derecha o de la izquierda
2. Cuando llegar a la función deseada, presione el botón Set/OK



Botón Set/OK

Primero presione el botón de selección Manual/Automático, después configure según la tabla siguiente:

 <p><b>Indicador del Ciclo de Limpieza</b> Determina el tiempo del ciclo de limpieza. La RCU permite que usted elija entre las siguientes opciones.</p>	 <p><b>Rápido</b> Ciclo de 4 horas</p>	 <p><b>Eficiente (Configuración predeterminada)</b> Ciclo de 6 horas para uso diario</p>	 <p><b>Extra</b> Ciclo de 8 horas</p>	
 <p><b>Indicador del Tiempo de Retraso</b> Determina cuando el limpiador de piscina empieza a operar. Un retraso permite que la suciedad se establezca en el fondo de la piscina.</p>	 <p><b>Inicio Inmediato (Configuración predeterminada)</b></p>	 <p><b>Retraso de Una Hora</b></p>	 <p><b>Retraso de Dos Horas</b></p>	
 <p><b>Indicador de la Acción de Limpieza</b> Permite que usted elija entre las siguientes opciones.</p>	 <p><b>Standard (Configuración predeterminada)</b> Limpieza de piso y pared.</p>	 <p><b>Ultra-limpio</b> Más succión y movimiento más lento. (piso y pared)</p>	 <p><b>Solamente el Piso</b> Limpia solamente el piso y los rincones.</p>	 <p><b>Solamente las Paredes</b> Limpia solamente las paredes y la línea de agua.</p>

**Nota:**

- Pasados 2 minutos, si ninguno de los botones fue presionado, la Unidad de Control Remoto se cierra y el Limpiador de Piscina continuará operando en la configuración anterior.
- Cuando las opciones "Ultra-Limpio" y "Solamente Paredes" concluyen sus ciclos, la Limpiador de Piscina retornará a la configuración preestablecida.

**DE**

# Dolphin PROX 2 Gyro Robotic Pool Reiniger

## Bedienungsanleitung

---

### Inhalt

1. EINFÜHRUNG.....	42
2. TECHNISCHE BESCHREIBUNG.....	42
3. WARNUNGEN UND SICHERHEITSHINWEISE.....	42
3.1. Warnungen.....	42
3.2. Sicherheitshinweise .....	42
4. POOLREINIGER-TEILE.....	43
5. VERWENDUNG DES POOLREINIGERS.....	44
5.1. Einstellung.....	44
5.2. Einsetzen des Poolreinigers in den Pool.....	45
5.3. Entnahme des Poolreinigers aus dem Pool.....	45
5.4. Wartung.....	46
5.5. Lagerung außerhalb der saison.....	47
6. STROMVERSORGUNG .....	48
7. FERNBEDIENUNGSEINHEIT.....	49
CADDY MONTAGE.....	81

# Dolphin PROX 2 Gyro Pool Reiniger

## Bedienungsanleitung

### 1. EINFÜHRUNG

Vielen Dank, dass Sie einen Maytronics Roboter-Poolreiniger erworben haben.

Wir sind sicher, dass Ihr Maytronics Roboter-Poolreiniger für verlässliche, bequeme und kostengünstige Poolreinigung sorgen wird. Seine verlässliche Filterung unter allen Poolbedingungen, das aktive Abbürsten und die die gesamte Fläche erreichende Bürste erhöhen maximal die Pool-Hygiene.

Der Roboter-Poolreiniger von Maytronics bietet hochentwickelte Reinigungstechnologie, dauerhafte Leistung und einfache Wartung. Sie und Ihre Familie können das Bad in der Gewissheit eines vollkommen sauberen Pools genießen.

### 2. TECHNISCHE BESCHREIBUNG

Motorschutz: IP 68

Mindesttiefe: 0.80m/2.6ft

Höchsttiefe: 5m/16.4ft

### 3. WARNUNGEN UND SICHERHEITSHINWEISE

#### 3.1. Warnungen



- Nur das Original-Stromversorgungsgerät verwenden
- Stellen Sie sicher, dass die Steckdose durch einen FI-Schutzschalter (GFI) oder einen Fehlerstromschutzschalter (ELI) geschützt ist
- Halten Sie das Stromversorgungsgerät von stehendem Wasser fern
- Positionieren Sie das Stromversorgungsgerät mindestens 3m/10ft vom Poolrand entfernt
- Gehen Sie nicht in den Pool, solange der Poolreiniger arbeitet
- Stecken Sie das Stromversorgungsgerät aus, bevor Sie Wartungsarbeiten durchführen

#### 3.2. Sicherheitshinweise

Wenn Sie den Poolreiniger nicht verwenden, lagern Sie ihn auf dem Caddy an einem schattigen Platz. Verwenden Sie den Poolreiniger nur bei folgenden Wasserbedingungen:

Chlor	Maximal 4 ppm
pH	7,0 - 7,8
Temperatur	6 – 34°C (43-93°F)
NaCl	Maximum = 5000 ppm

## 4. POOLREINIGER-TEILE

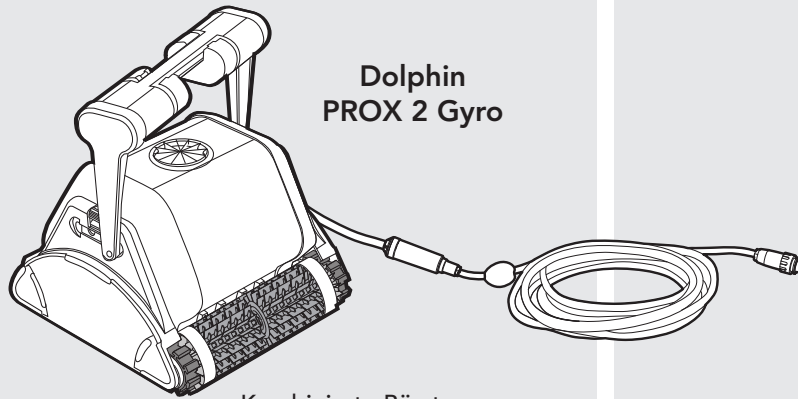

**Dolphin  
PROX 2 Gyro**

**Kombinierte Bürste**  
für grobe Keramikoberflächen  
und Mosaikfliesen

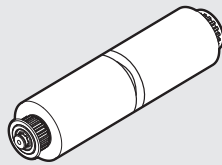

**Wonder-Bürste**  
für glatte keramische Materialien  
(Optional)

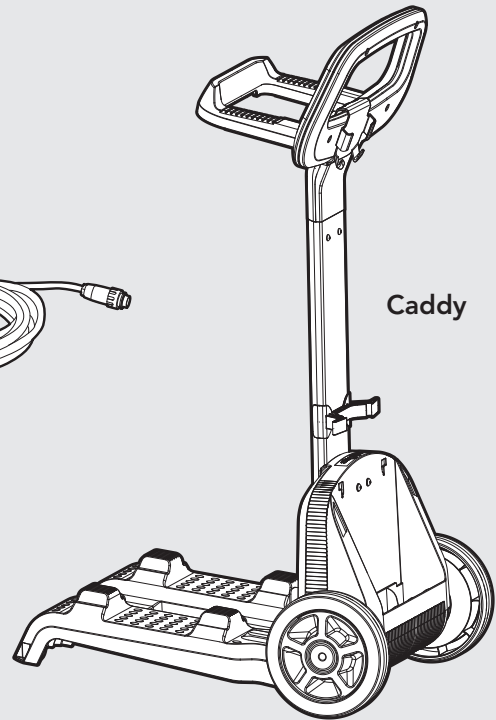

**Caddy**

### Unterer Deckel und Filterbeutel

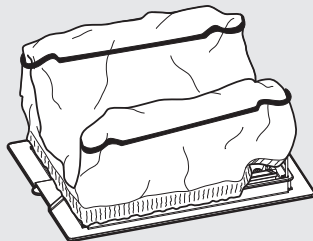

**Filterbeuteloptionen**  
Fein - Standard  
Ultrafein - Extra



**Fernbedienungseinheit**

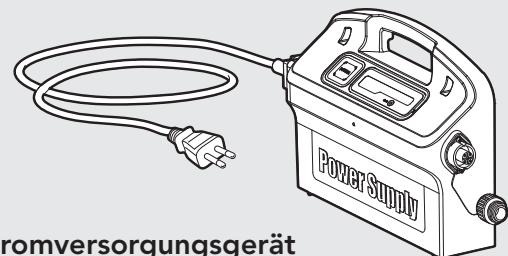

**Stromversorgungsgerät**

## 5. VERWENDUNG DES POOLREINIGERS

### 5.1. Einstellung

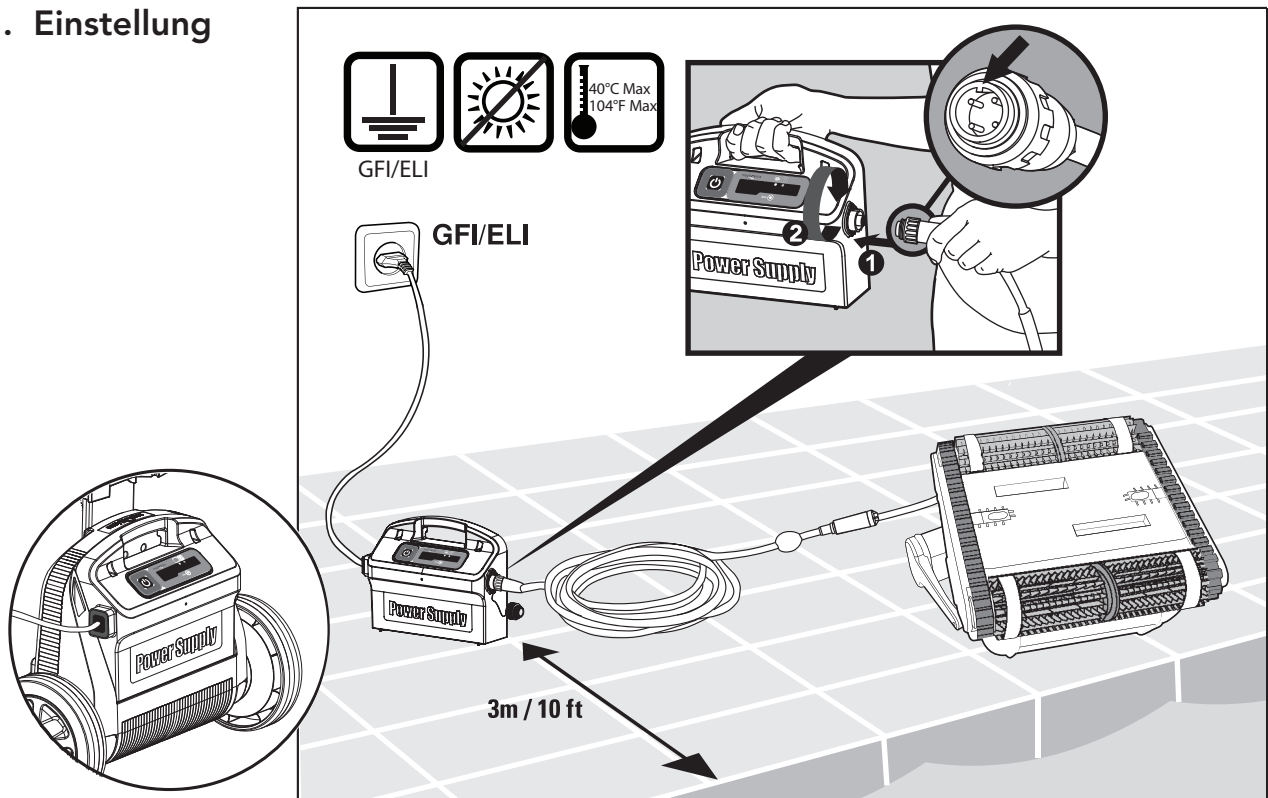

Ändern Sie die Position der Griffs für die Seitwärtsbewegung des Roboters entlang der Wasserlinie.

Um den Griffwinkel einzustellen:

- A. Drücken Sie den Riegel nach unten und halten Sie ihn in dieser Position.
- B. Bewegen Sie den Griff in die gewünschte Position, und lassen Sie den Riegel los um den Griff in dieser Position zu halten.

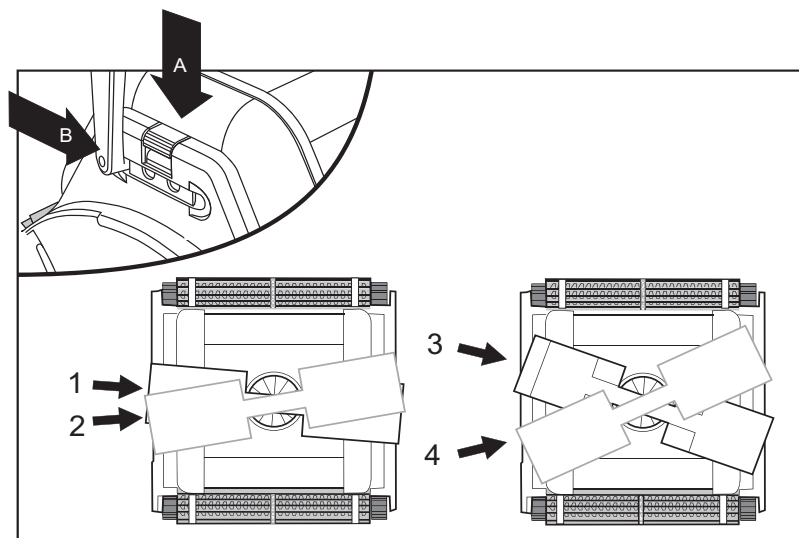

## 5.2. Einsetzen des Poolreinigers in den Pool

Wenn die Wonder - Bürste/ die Wonder - Ringe trocken sind, tauchen Sie sie in Wasser bis sie weich geworden sind.

Schwenken sie den roboter von seite zu seite oder kippen sie ihn um, um den lufteinschluss zu befreien. Lassen Sie ihn auf den Boden sinken.

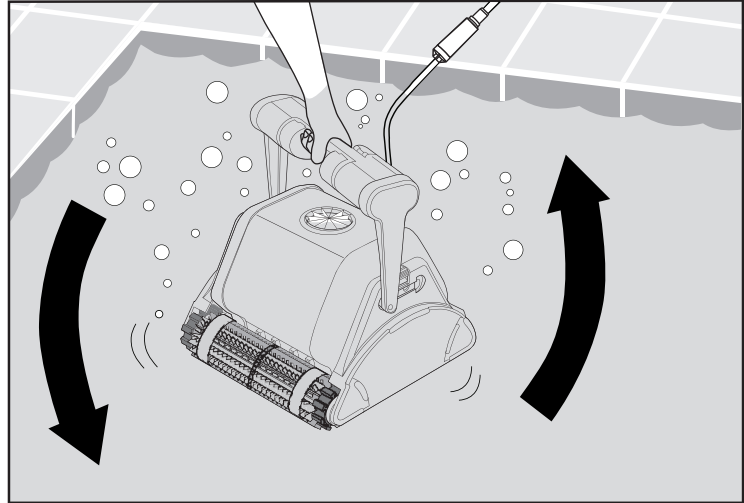

Stellen Sie das Stromversorgungsgerät auf ON

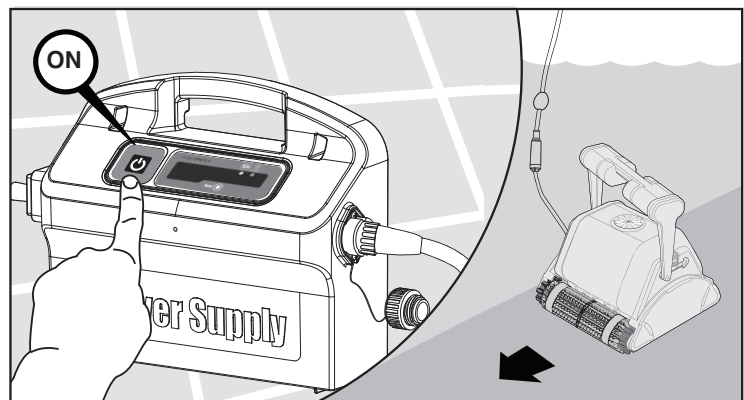

## 5.3. Entnahme des Poolreinigers aus dem Pool

Der roboter wird am ende des waschzyklus automatisch abschalten.

 Schalten Sie das Gerät AUS und ziehen Sie den Netzstecker

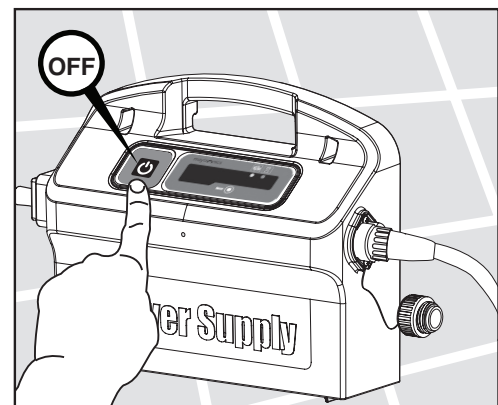

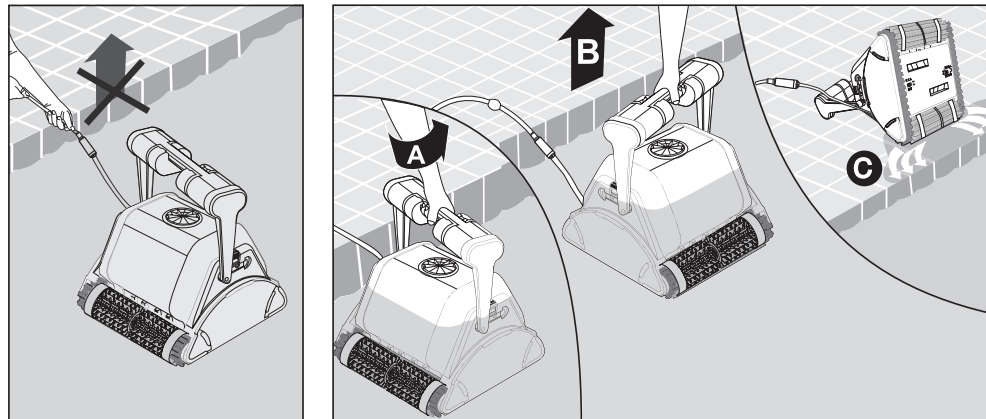

Ziehen Sie den Poolreiniger am Schwimmkabel zum Poolrand.

**!** ZIEHEN SIE DEN POOLREINIGER NICHT AM KABEL AUS DEM POOL

#### 5.4. Wartung

Reinigen Sie den Filterbeutel mit einem Wasserschlauch. Reinigen Sie die Bürsten regelmäßig mit einem Wasserschlauch. Es ist empfehlenswert, den filterbeutel regelmäßig in einer waschmaschine zu waschen. Betätigen sie ein synthetisches waschprogramm.

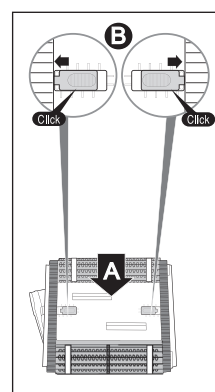
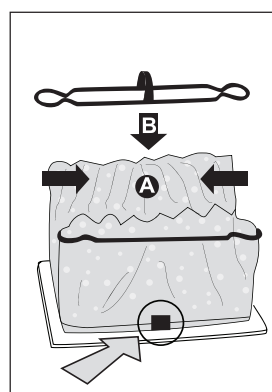
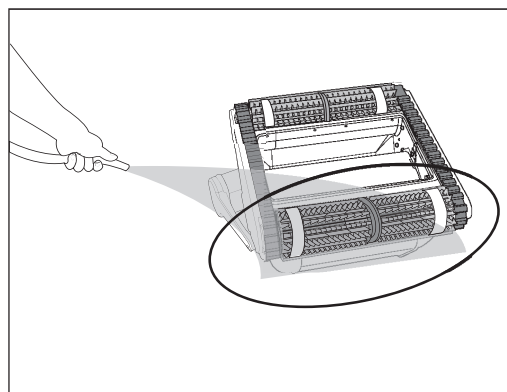
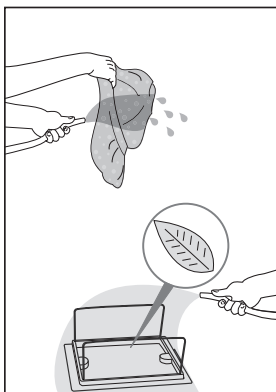
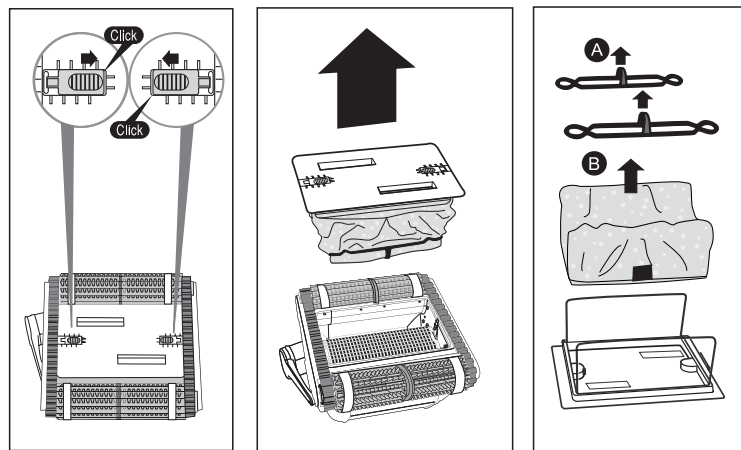



## Reinigen des Flügelrades

**!** Ziehen Sie den Netzstecker

Wenn Sie Steinchen im Flügelrad bemerken, die sich verklemmt haben, öffnen Sie das Flügelrad und entfernen die Steinchen.

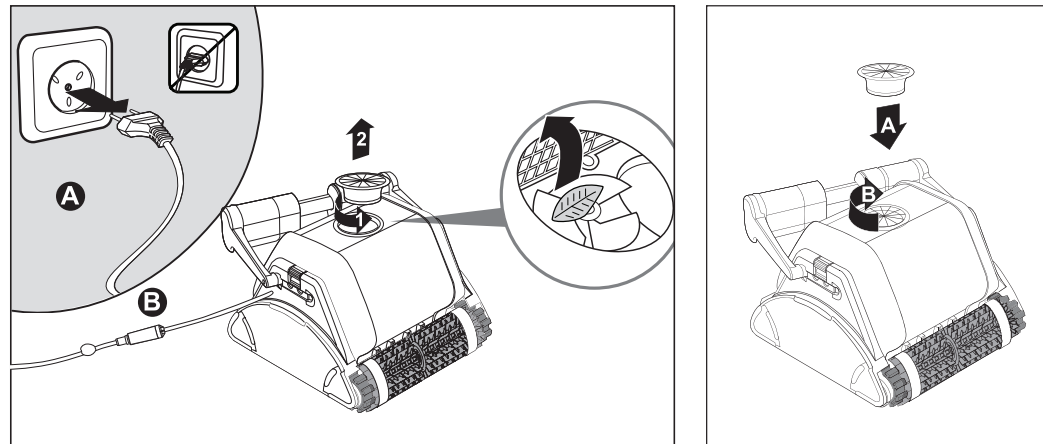

## Kabel

Um die Knickstellen zu entfernen, ziehen Sie das Kabel vollständig aus und lassen es für mindestens einen Tag in der Sonne liegen.

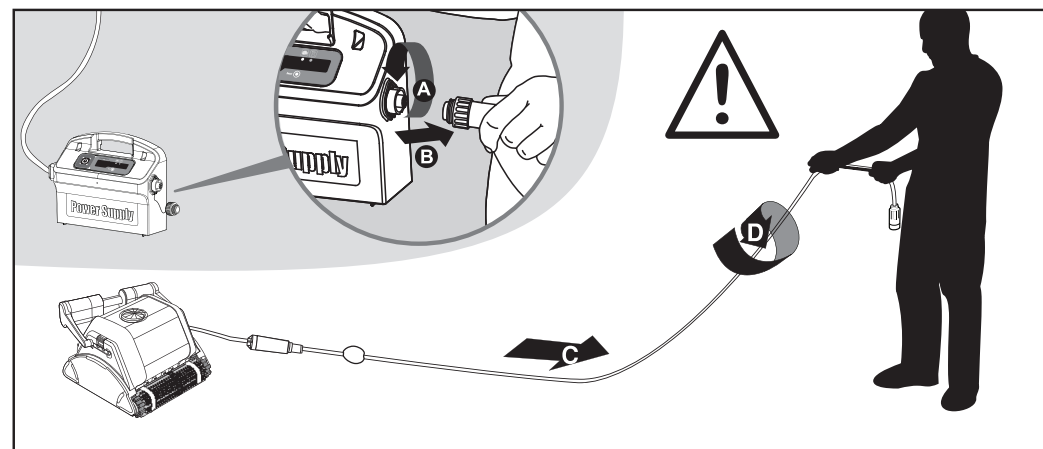

## 5.5. Lagerung außerhalb der saison

Wenn der Poolreiniger für längere Zeit nicht im Einsatz ist, führen Sie die folgenden Schritte für dessen Lagerung aus:

- Stellen Sie sicher, dass sich kein Wasser mehr im Poolreiniger befindet
- Reinigen Sie gründlich den Filterbeutel und setzen Sie ihn wieder ein
- Rollen Sie das Kabel auf, so dass es nicht geknickt wird, und legen Sie es auf den Caddy
- Lagern Sie den Poolreiniger in einem geschützten Bereich, entweder auf dem dazugehörigen Caddy oder einfach auf dem Kopf stehend

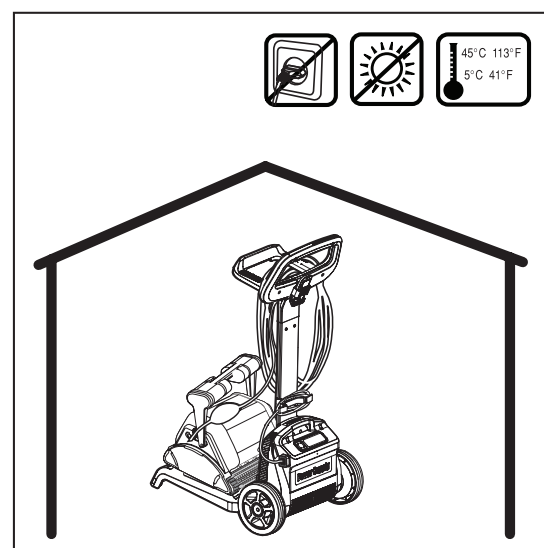

## 6. STROMVERSORGUNG

Digitale Stromversorgungseinheit mit „Schaltmodus“ mit Anzeige für vollen Filterbeutel und Verzögerungs-Anzeige.

- Input - 100-250 AC Volts
- 50-60 Hertz
- 180 Watt
- Output - <30 VDC
- IP 54

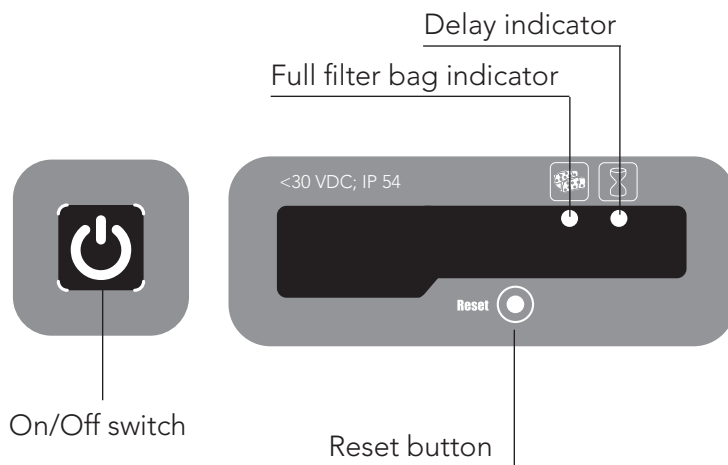
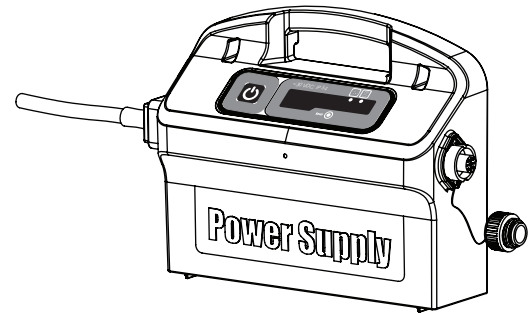

### Anzeige für vollen Filterbeutel und Rücksteltaste (Reset)

Die Stromversorgungseinheit ist mit einer Anzeige des Filterbeutelstatus ausgestattet.

Die rote Leuchtdiode zeigt zwei Filterzustände an.

- Wenn sie blinkt – bedeutet dies, dass der Filterbeutel teilweise verstopft ist.
- Wenn Sie aufleuchtet – bedeutet dies, dass der Filter verstopft ist und geleert und gereinigt werden muss.

Wenn die Leuchtdiode sich nicht abschaltet nachdem der Filterbeutel geleert und gereinigt wurde, drücken Sie auf die Rücksteltaste, während der Roboter arbeitet.



### Verzögerungsanzeige (Delay)

Die Stromversorgungseinheit ist mit einer Verzögerungsanzeige ausgestattet, die anzeigt, ob die Verzögerungsoption aktiviert wurde oder nicht (über die Fernbedienungseinheit).

## 7. FERNBEDIENUNGSEINHEIT

Die Fernbedienungseinheit bietet Ihnen zwei Betriebsmoden den automatischen Modus und den manuellen Steuermodus.

Im automatischen Modus können alle Reinigungsparameter geändert werden.

Im manuellen Steuermodus kann die Richtung des Schwimmbadreinigers manuell gesteuert werden.

### Das Bedienfeld der Fernbedienungseinheit

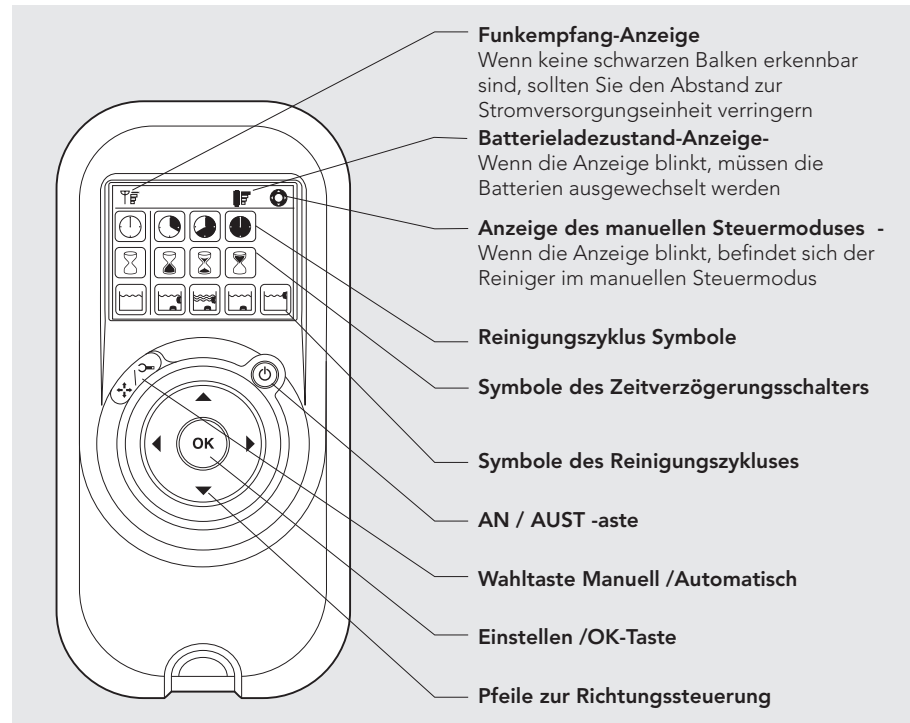

#### Manueller Steuermodus

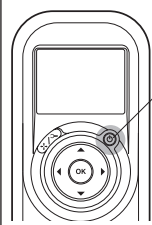

An/Aus-Taste

1. Drücken Sie einmal auf die AN/Aus-Taste – die Fernbedienungseinheit schaltet daraufhin in den manuellen Steuermodus.
2. Um die Richtung des Reinigers manuell kontrollieren zu können, müssen Sie die Richtungspfeile benutzen (siehe rechts).

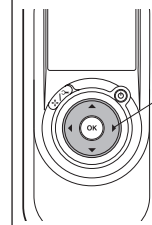

Richtungspfeile

#### Verlassen des manuellen Steuermodus und Einstellen des automatischen Moduses

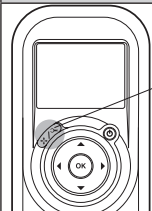

Wahltaste Manuell / Automatisch

1. Drücken Sie einmal auf die Wahl-taste Manuell/Automatisch, um den manuellen Steuermodus zu verlassen.
2. Daraufhin leuchtet der digitale Bildschirm auf und zeigt drei Reihen von Funktionssymbolen in der Standardeinstellung.

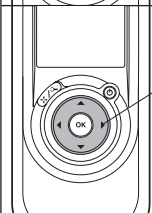
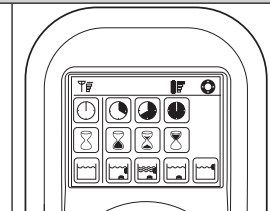





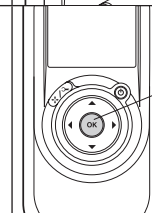







Richtungspfeile

1. Um die Parameter zu ändern, drücken Sie auf die Pfeile nach oben oder unten. Jetzt können Sie die Parametereinstellungen mit Hilfe der Pfeile nach rechts oder links auswählen.
2. Sobald Sie die gewünschte Funktion erreicht haben, drücken Sie auf die Taste Einstellen/OK.



Taste Einstellen /OK

Zuerst müssen Sie auf die Wahl taste Manuell/Automatisch drücken und dann den Modus gemäss folgender Tabelle einstellen:

 <p><b>Reinigungsmodus-Anzeige</b> Hier können Sie die Reinigungszyklus-Zeit einstellen. Sie können mit Hilfe der RCU zwischen folgenden Optionen wählen.</p>	 <p><b>Schnell</b> 4 Stunden -Zyklus</p>	 <p><b>Effizient</b> (Standardeinstellung) 6 Stunden -Zyklus für tagtägliche Benutzung</p>	 <p><b>Extra</b> 8 Stunden -Zyklus</p>	
 <p><b>Zeitverzögerungs-Anzeige</b> Hier können Sie festlegen, wann der Schwimmbad-Reiniger mit der Reinigung beginnt. Eine Verzögerung ermöglichtes dem Schmutz, sich auf dem Beckenboden abzusetzen.</p>	 <p><b>Sofortiger Start</b> (Standardeinstellung)</p>	 <p><b>Verzögerung von einer Stunde</b></p>	 <p><b>Verzögerung von zwei Stunden</b></p>	
 <p><b>Anzeige der Reinigungs-Aktivität</b> Ermöglicht Ihnen, eine der folgenden Optionen zu wählen.</p>	 <p><b>Standard</b> Boden und Wandreinigung (Standardeinstellung)</p>	 <p><b>Ultra-Sauber</b> Stärkere Saugleistung und langsamere Bewegung. (Boden-und Wände)</p>	 <p><b>Nur Boden</b> Reinigt nur den Beckenboden und die Wölbung.</p>	 <p><b>Nur Wände</b> Reinigt die Wände und die Wasserlinie.</p>

**Hinweis:**

- Wenn nach 2 Minuten noch keine Taste gedrückt worden ist, schaltet sich die Fernbedienungseinheit ab und der Schwimmbadreiniger arbeitet weiter mit den vorher eingestellten Einstellungen.
- Wenn die Optionen "Ultra- Sauber" und "Nur Wände" ihren Zyklus beendet haben, kehrt die Schwimmbadreiniger zu den Standardeinstellungen zurück.

**NL**

## **Dolphin PROX 2 Gyro zwembadreiniger** Werkwijze instructies

---

### **Contents**

1. INTRODUCTIE .....	52
2. SPECIFICATIES .....	52
3. WAARSCHUWINGEN EN OPGELET .....	52
3.1. Waarschuwingen .....	52
3.2. Opgelet .....	52
4. ONDERDELEN VAN ZWEMBADREINIGER .....	53
5. DE ZWEMBADREINIGER GEBRUIKEN .....	54
5.1. Instellen .....	54
5.2. De Zwembadreiniger in het zwembad plaatsen .....	55
5.3. De Zwembadreiniger uit het zwembad halen .....	55
5.4. Onderhoud .....	56
5.5. Opslag buiten het seizoen .....	57
6. VOEDING .....	58
7. AFSTANDSBEDIENING (RCU) .....	59
CADDY MONTAGE .....	81

# Dolphin PROX 2 Gyro zwembadreiniger

## Werkwijze instructies

### 1. INTRODUCTIE

Dank u wel dat u een Maytronics Robot Zwembadreiniger hebt aangeschaft.

We zijn er van overtuigd dat u met de Maytronics Robot Zwembadreiniger een betrouwbare, gemakkelijke en kosteneffectieve zwembadreiniger in handen heeft. De betrouwbare filtering in alle zwembadomstandigheden, actieve borsteling en de borstel die alle oppervlakken beklimt, zorgen voor maximale zwembadhygiëne.

De Robot Zwembadreinigers van Maytronics bieden geavanceerde reinigingstechnieken, langdurige prestaties en gemakkelijk onderhoud. U en uw familieleden kunnen rustig gaan zwemmen in het volle vertrouwen dat uw zwembad helemaal schoon is.

### 2. SPECIFICATIES

Motorbescherming: IP 68

Minimale diepte: 0.80m/2.6ft

Maximale diepte: 5m/16.4ft

### 3. WAARSCHUWINGEN EN OPGELET



#### 3.1 Waarschuwingen

- Gebruik alleen de originele, meegeleverde voedingsbron
- Zorg dat de elektrische uitgang is beschermd door een aardlekschakelaar of een aardlekstroomonderbreker
- Zorg dat de voedingsbron zich buiten stilstaand water bevindt
- Plaats de voedingsbron tenminste 3m/10ft van de zwembadrand
- Stap niet in het zwembad terwijl de zwembadreiniger actief is
- Koppel de voedingsbron los alvorens er onderhoudswerkzaamheden aan uit te voeren

#### 3.2 Opgelet

Sla de zwembadreiniger op de Caddy op in een schaduwrijk gebied wanneer deze niet in gebruik is. Gebruik de zwembadreiniger alleen in de volgende wateromstandigheden:

Chloor	Max. 4 ppm
pH	7.0 – 7.8
Temperatuur	6 – 34°C (43-93°F)
NaCl	Maximum = 5000 ppm

## 4. ONDERDELEN VAN ZWEMBADREINIGER

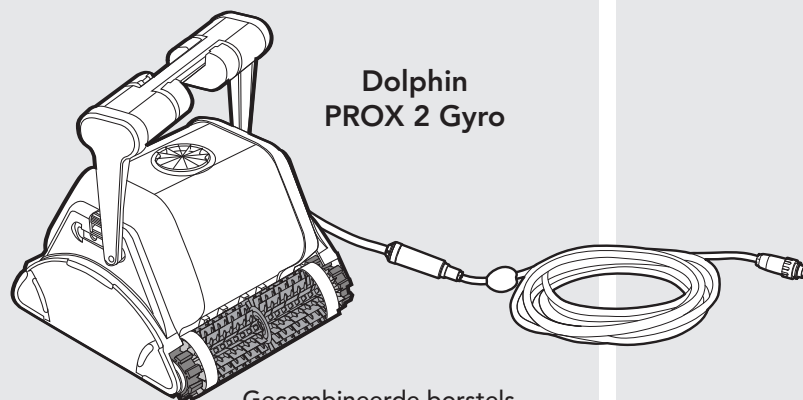

**Dolphin  
PROX 2 Gyro**

Gecombineerde borstels  
voor ruige keramische  
oppervlakken en mozaïektegels

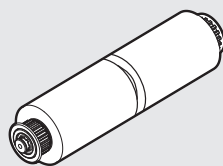

Wonder borstel  
voor gladde keramische  
oppervlakken  
(Optioneel)

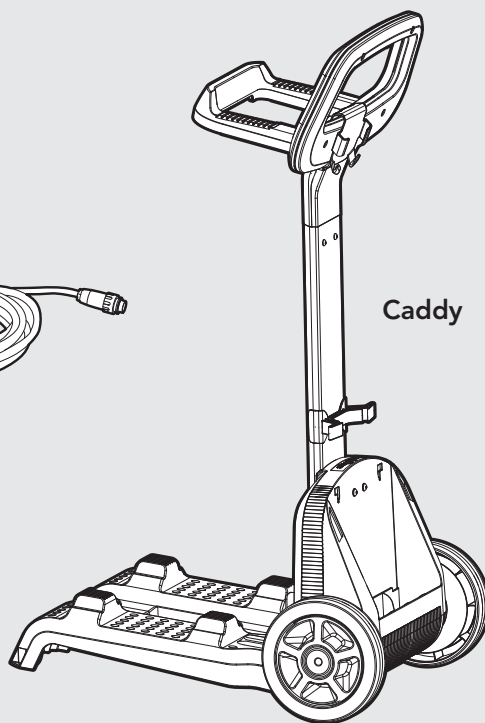

**Caddy**

**Onderste deksel en filterzak**

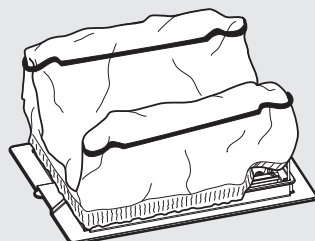

Filterzak opties:  
Fijn - standaard  
Ultrafijn - extra



**Afstandsbediening**

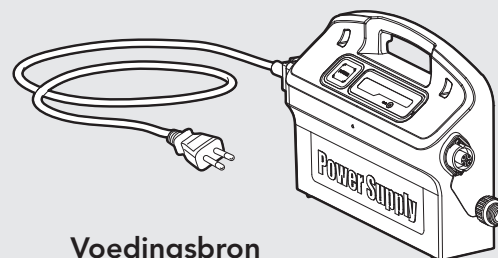

**Voedingsbron**

## 5. DE ZWEMBADREINIGER GEBRUIKEN

### 5.1. Instellen

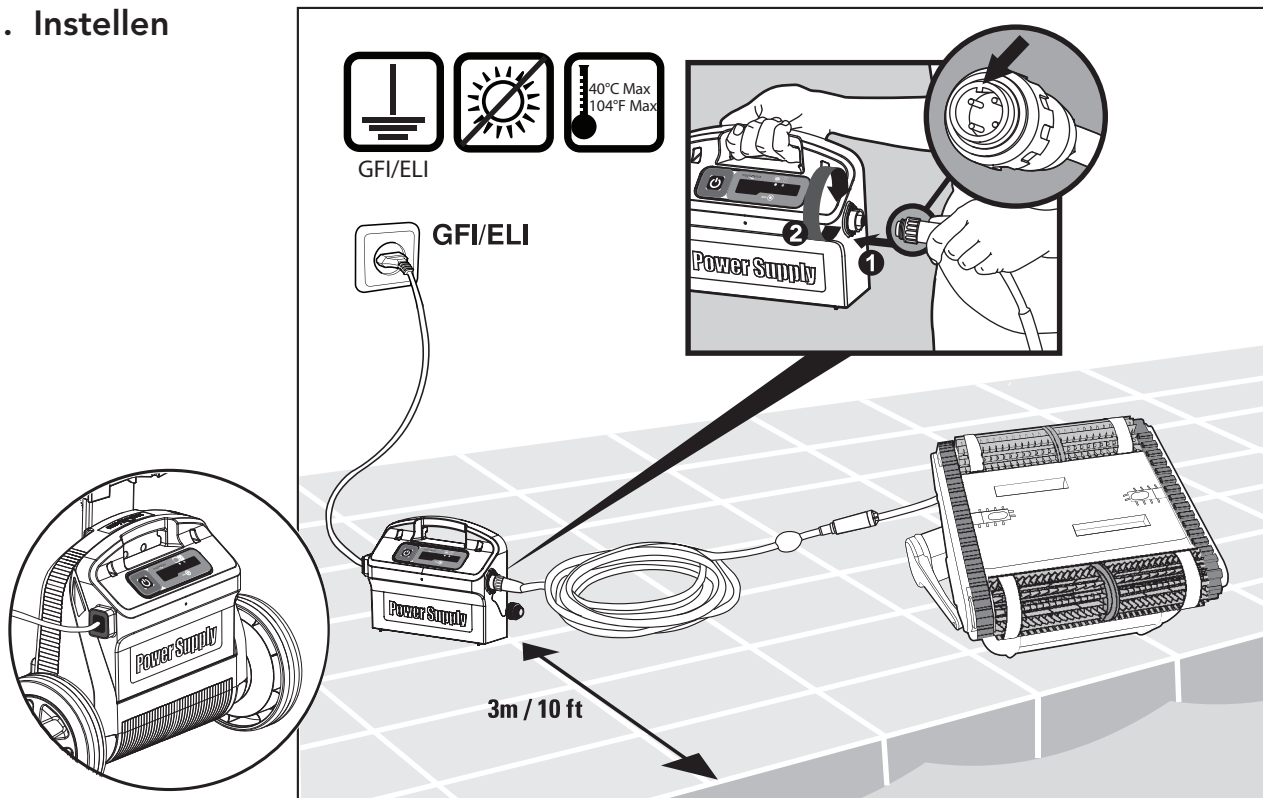

Verander met een zijwaartse diagonale beweging de positie van de handgreep op de waterlijn.

Aanpassen van de handvat hoek:

- A. Druk de grendel naar beneden en houd het op zijn plaats.
- B. Beweeg het handvat in de gewenste positie en laat de grendel los voor het in plaats houden van het handvat.

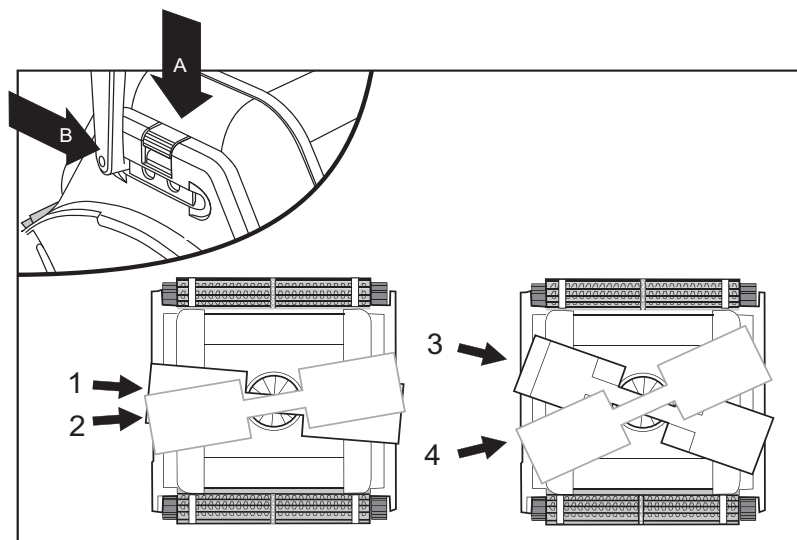



## 5.2. De Zwembadreiniger in het zwembad plaatsen

Wanneer de Wonder borstel/Wonder ringen droog zijn, zuig ze dan vol met water tot ze zacht worden.

Schud de robot heen en weer, of houd hem onderste boven om vastgelopen lucht vrij te laten. Laat het apparaat afdrijven naar de zwembadbodem.

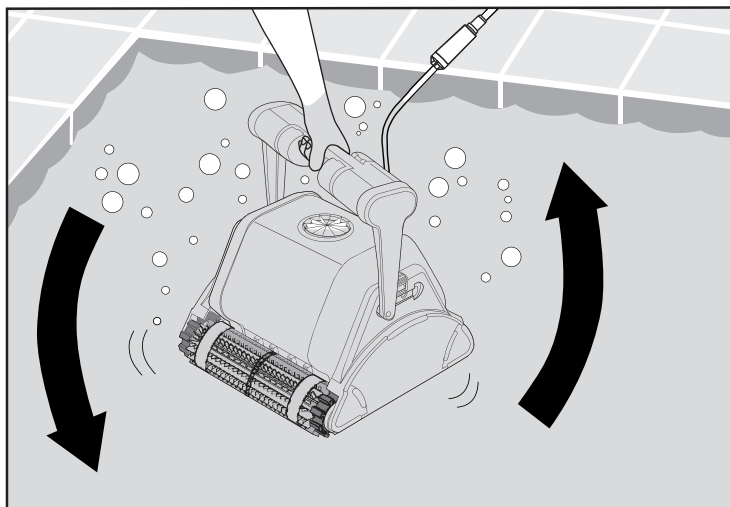

Schakel de voedingsbron AAN

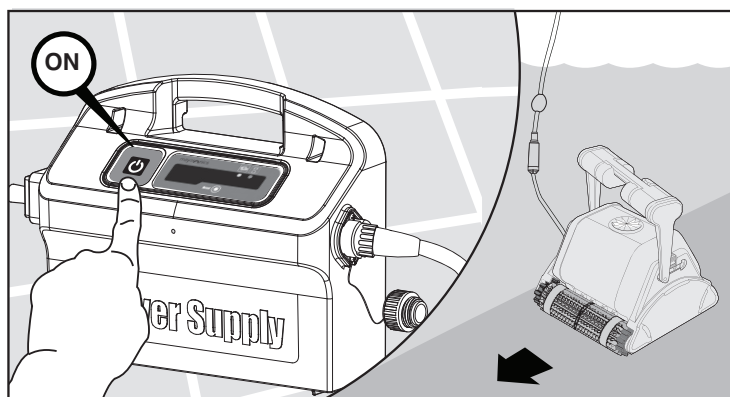

## 5.3. De Zwembadreiniger uit het zwembad halen

De robot slaat automatisch af aan het einde van de schoonmaak cyclus.



Schakel het toestel uit en haal de voedingsbron uit het stopcontact.

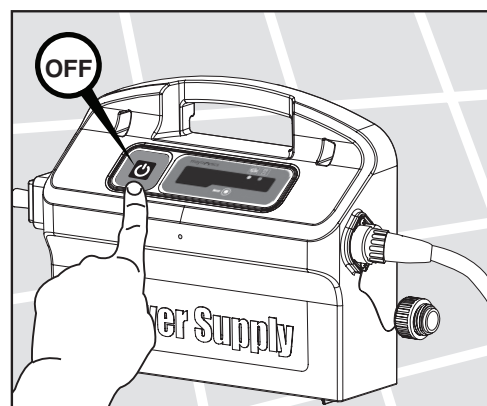

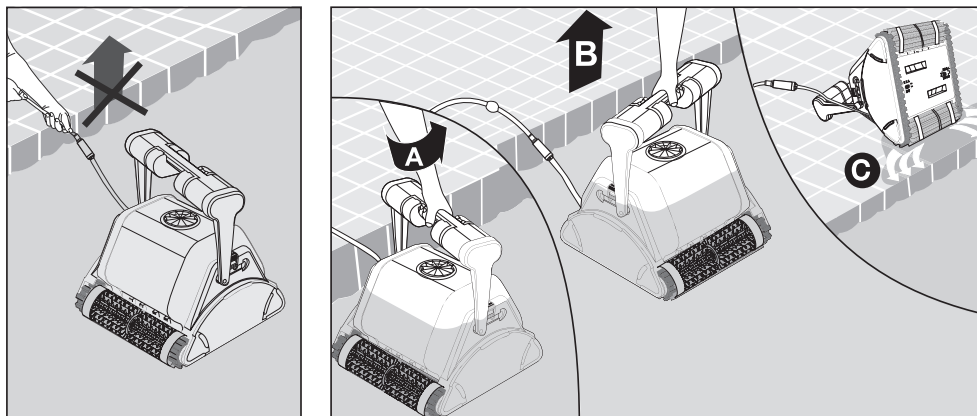

Haal de zwembadreiniger met behulp van de drijvende kabel naar de rand van het zwembad.

 TREK DE ZWEMBADREINIGER NIET AAN DE KABEL UIT HET ZWEMBAD

### 5.4. Onderhoud

Reinig de filterzak met een slang.  
 Reinig de borstels periodiek met een slang.  
 Aanbevolen wordt om de filterzak regelmatig in de wasmachine met een syntetisch wasprogramma te wassen.

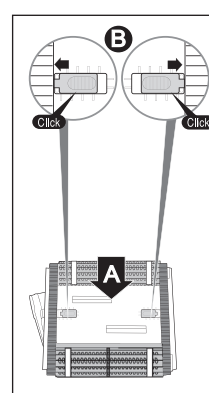
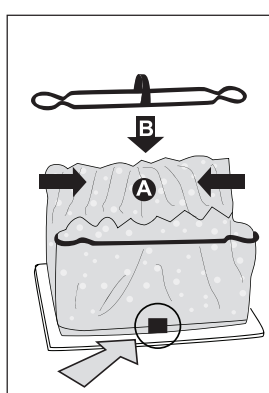
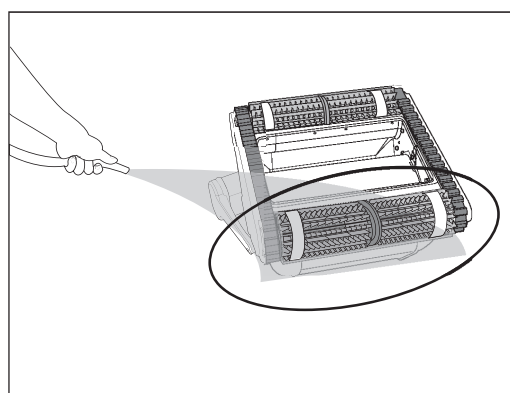
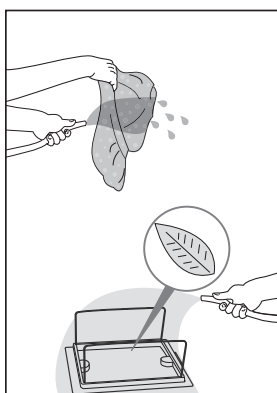
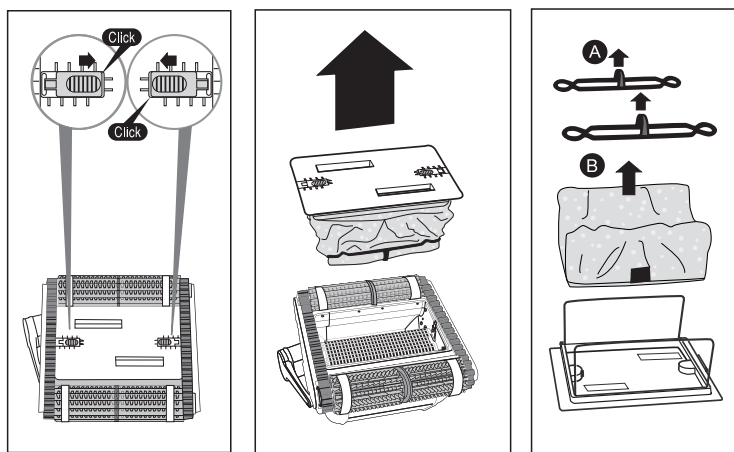

## De impeller reinigen

**!** Koppel de voedingsbron los

Wanneer u vuil ziet dat in de impeller is gevangen, open dan de impeller en verwijder het vuil.

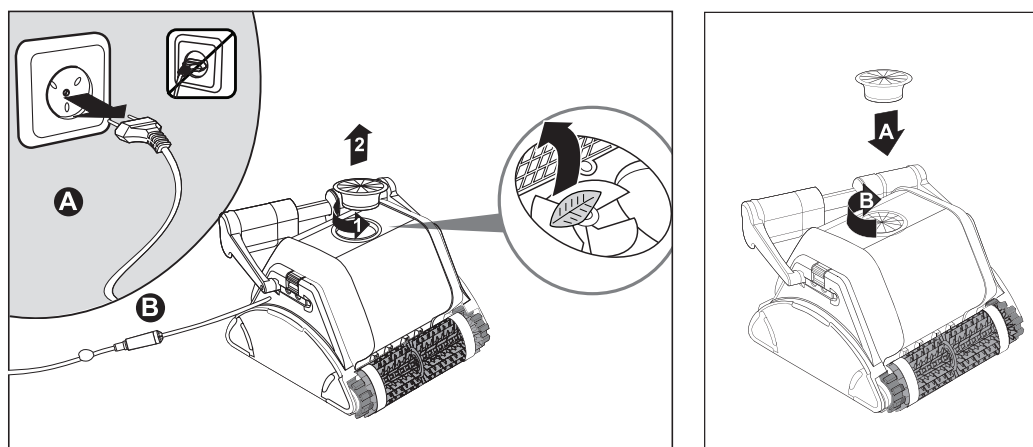

## Kabel

Leg de kabel geheel uit om kinken te verwijderen. Laat de kabel tenminste één dag in de zon liggen.

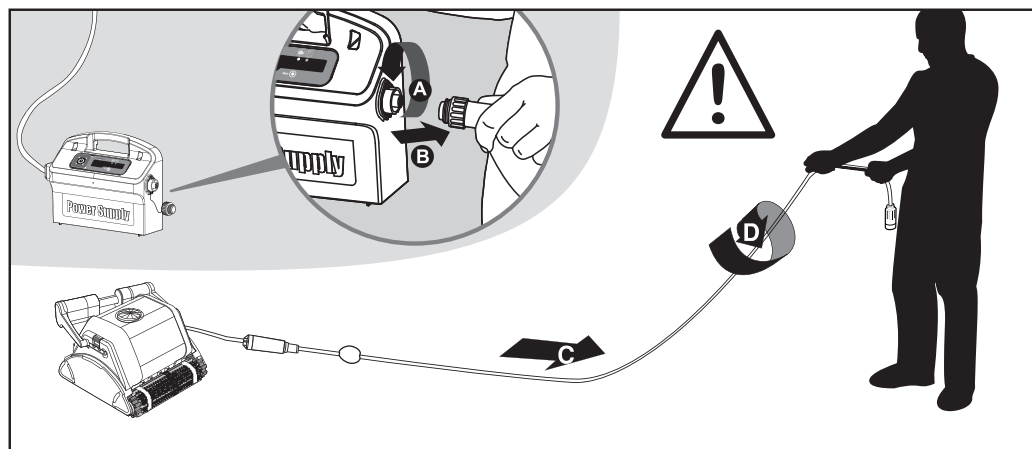

## 5.5. Opslag buiten het seizoen

Voer de volgende stappen uit wanneer u de zwembadreiniger opslaat wanneer deze tijdens een lange periode niet gebruikt zal worden:

- Zorg dat er geen water in de zwembadreiniger achterblijft
- Reinig de filterzak grondig en plaats deze terug
- Rol de kabel zo op dat er geen kinken in zitten en plaats het toestel op de Caddy
- Sla de zwembadreiniger op in een beschermd gebied. Doe dit op de Caddy of plaats de zwembadreiniger onderste boven



## 6. VOEDING

Digitale "switch-mode" voeding met indicator voor volle filterzak en vertraging.

- Input - 100-250 AC Volts
- 50-60 Hertz
- 180 Watt
- Output - <30 VDC
- IP 54

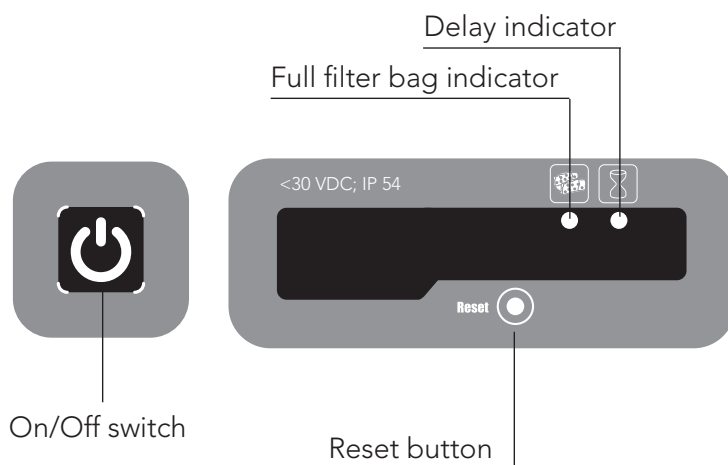
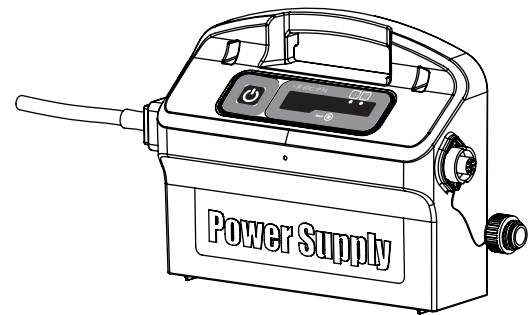

### Volle filterzak indicatie en Reset knop

De stroomtoevoer eenheid bevat een filterzak status indicator.

De rode LED geeft twee condities aan.

- Knipperen – de filterzak is gedeeltelijk geblokkeerd.
- Oplichten – de filterzak is geblokkeerd en moet worden geleegd en schoongemaakt.

Als de LED na het legen en schoonmaken van de filterzak niet dooft, druk dan tijdens het werken van de robot op de Reset knop.



### Uitsteltijd indicator (Delay)

De stroomtoevoer eenheid bevat een Uitsteltijd indicator die aangeeft of de uitsteltijd optie (via de afstandsbediening) is geactiveerd.

## 7. AFSTANDSBEDIENING (RCU)

De RCU heeft twee werkmodi – de Automatische modus en de Handmatige werkriching bedieningsmodus.

In de Automatische modus kunnen alle schoonmaakparameters worden veranderd.

In de Handmatige werkriching bedieningsmodus kan de schoonmaakrichting van het zwembad handmatig worden bestuurd.

### Het controlepaneel van de afstandsbediening















#### Handmatige werkriching bedieningsmodus

<p>Aan/uit knop</p>	<ol style="list-style-type: none"> <li>1. Druk een keer op de Aan/uit knop - de RCU begint in de Handmatige werkriching bedieningsmodus.</li> <li>2. Om de richting van de schoonmaker handmatig te bedienen gebruikt u de richtingpijltjes (Zie rechts).</li> </ol>	<p>Richtingpijltjes</p>
---------------------	--	-------------------------

#### Van de Handmatige werkriching bedieningsmodus naar de Automatische modus

<p>Selectieknop Handmatig/Automatisch</p>	<ol style="list-style-type: none"> <li>1. Om uit de Handmatige werkriching bedieningsmodus te gaan drukt u maar EEN KEER op de selectieknop Handmatig/Automatisch.</li> <li>2. Het digitale scherm licht op en u ziet drie rijen functie iconen in de standaard modus.</li> </ol>	
<p>Richtingpijltjes</p>	<ol style="list-style-type: none"> <li>1. Om de parameters te veranderen drukt u op de pijltjes naar boven of beneden. Om de parameter instellingen te kiezen gebruikt u de rechter of linker pijltjes.</li> <li>2. Als u de vereiste functie heeft bereikt drukt u op de Instellen/OK knop.</li> </ol>	<p>Instellen/OK knop</p>

Druk eerst op de selectieknop Handmatig/Automatisch en stel vervolgens de volgende tabel in:

 <p><b>Schoonmaakcyclus indicator</b> Hiermee wordt de schoonmaakcyclus tijd ingesteld. Met de RCU kunt u tussen de volgende opties kiezen.</p>	 <p><b>Snel</b> 4 uur cyclus</p>	 <p><b>Efficiënt</b> 6 uur cyclus voor dagelijks gebruik. <b>(standaard instelling)</b></p>	 <p><b>Extra</b> 8 uur cyclus</p>	
 <p><b>Vertragingstijd indicator</b> Dit bepaalt wanneer de zwembadschoonmaker gaat werken. Met vertraging kan het vuil op de vloer van het zwembad komen.</p>	 <p><b>Gelijk beginnen (standaard instelling)</b></p>	 <p><b>Een uur vertraging</b></p>	 <p><b>Twee uur vertraging</b></p>	
 <p><b>Schoonmaakactie indicator</b> Hiermee kunt u kiezen uit de volgende opties.</p>	 <p><b>Standaard</b> Vloer en muren schoonmaken. <b>(standaard instelling)</b></p>	 <p><b>Ultraschoon</b> Krachtiger zuigen met langzamere beweging. (Vloer en muren)</p>	 <p><b>Alleen vloer</b> Maakt alleen de vloer en nissen schoon</p>	 <p><b>Alleen muren</b> Maakt alleen de muren en wateroppervlak schoon</p>

**Opmerking:**

- Als er na 2 minuten niet op een knop wordt gedrukt gaat de afstandsbediening uit en werkt de zwembadschoonmaker volgens de eerder ingestelde instellingen.
- Als de cyclusopties "Ultraschoon" en "Alleen muren" voltooid zijn gaat de zwembadschoonmaker naar de Standaard instellingen.

**PT**

## **Dolphin PROX 2 Gyro limpador de piscinas** Instruções de operação

### **Conteúdo**

1. INTRODUÇÃO.....	62
2. ESPECIFICAÇÕES.....	62
3. AVISOS E PRECAUÇÕES.....	62
3.1. Avisos.....	62
3.2. Precauções.....	62
4. PEÇAS DO ASPIRADOR DE PISCINA.....	63
5. UTILIZAR O ASPIRADOR DE PISCINA.....	64
5.1. Instalação.....	64
5.2. Colocar o aspirador na piscina.....	65
5.3. Retirar o aspirador da piscina.....	65
5.4. Manutenção.....	66
5.5. Armazenamento fora de época.....	67
6. FONTE DE ALIMENTAÇÃO.....	68
7. CONTROLO REMOTO (RCU).....	69
CADDY MONTAGEM.....	81

# Dolphin PROX 2 Gyro limpador de piscinas

## Instruções de operação

### 1. INTRODUÇÃO

Obrigado por ter adquirido um aspirador de piscina robótico da Maytronics.

Temos a certeza que o seu aspirador de piscina robótico da Maytronics lhe irá proporcionar uma limpeza fiável, conveniente e eficiente da sua piscina. A sua filtração fiável em todas as condições da piscina, escovação ativa e a escova de ascensão para todas as superfícies melhoram a higiene da piscina ao máximo.

Os aspiradores de piscina robóticos da Maytronics proporcionam uma tecnologia de limpeza avançada, desempenho de longa duração e fácil manutenção. Você e a sua família terão toda a liberdade para desfrutar uma natação com plena confiança de que a sua piscina está completamente limpa.

### 2. ESPECIFICAÇÕES

Protección del motor: IP 68

Profundidad mínima: 0,80 m/ 2,6 ft

Profundidad máxima: 5,00 m/ 16,4 ft

### 3. AVISOS E PRECAUÇÕES



#### 3.1. Avisos

- Utilize apenas a fonte de alimentação fornecida (original)
- Certifique-se de que a tomada elétrica está protegida por um interruptor de falta de terra ou um interruptor de fuga à terra
- Mantenha a fonte de alimentação fora das poças de água
- Coloque a fonte de alimentação pelo menos a 3 m /10 ft da borda da piscina
- Não entre na piscina enquanto o aspirador de piscina estiver a funcionar
- Desligue a fonte de alimentação da tomada antes de qualquer atividade de manutenção

#### 3.2. Precauções

Quando não estiver a utilizar o aspirador de piscina, guarde-o no Caddy, numa zona de sombra. Use o aspirador de piscina apenas nas seguintes condições de água:

Cloro:	Máx. 4 ppm
pH	7,0 – 7,8
Temperatura:	6–34 °C (43–93 °F)
NaCl	Máximo = 5000 ppm



## 4. PEÇAS DO ASPIRADOR DE PISCINA

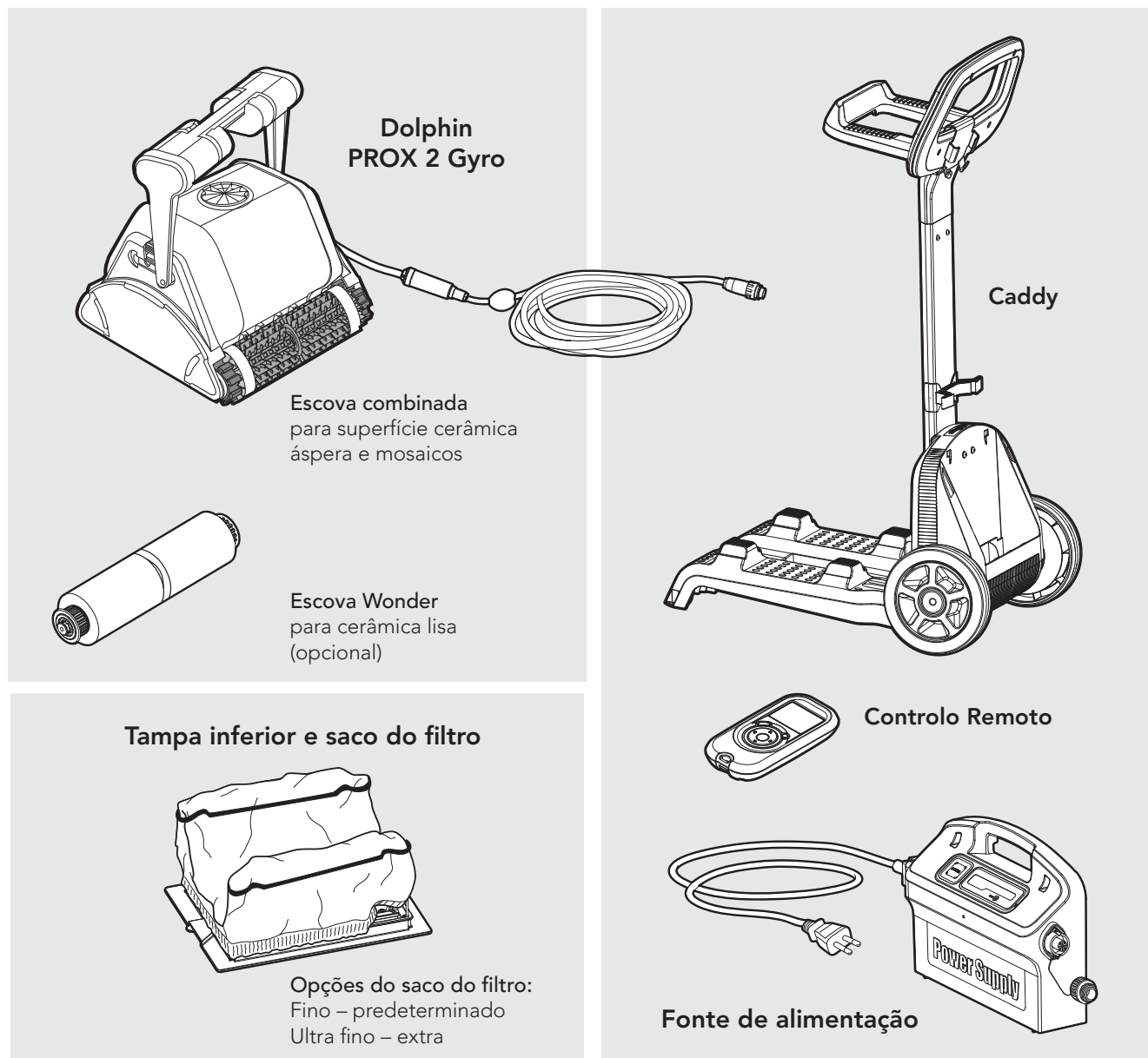

## 5. UTILIZAR O ASPIRADOR DE PISCINA

### 5.1. Instalação

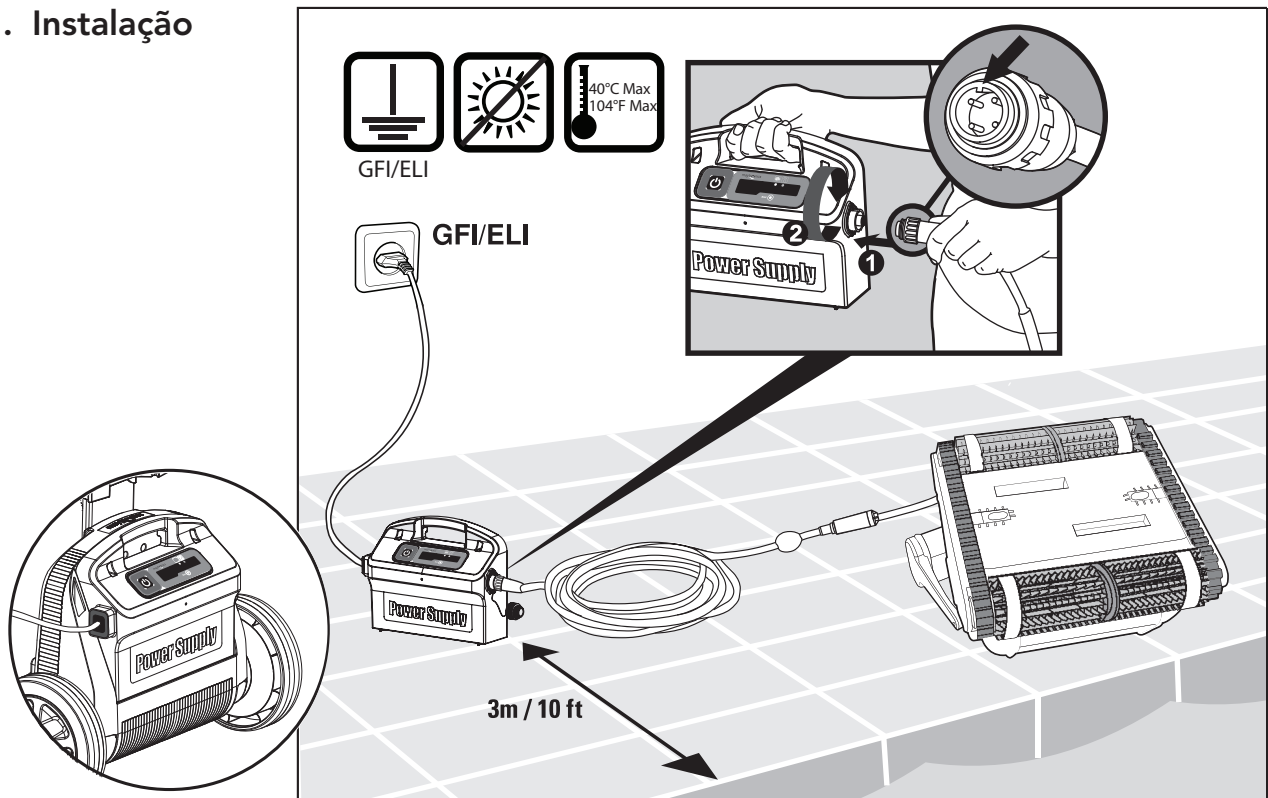

Mude a posição diagonal da alça para movimento lateral da linha de flutuação.

Para ajustar o ângulo da alça:

- A. Pressione a trava para baixo e segure-a nesta posição.
- B. Mova a alça para a posição desejada e solte a trava para manter a alça no lugar.

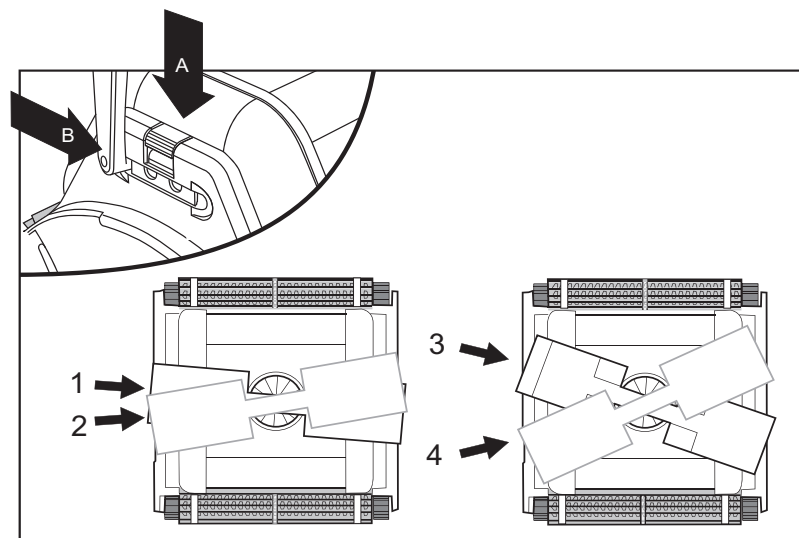

## 5.2. Colocar o aspirador na piscina

Se a escova Wonder / anéis Wonder estiverem secos, mergulhe-os em água até amaciarem.

Sacudir o robô lateralmente ou virar de cima para baixo para liberar ar confinado. Deixe-o afundar até ao fundo da piscina.

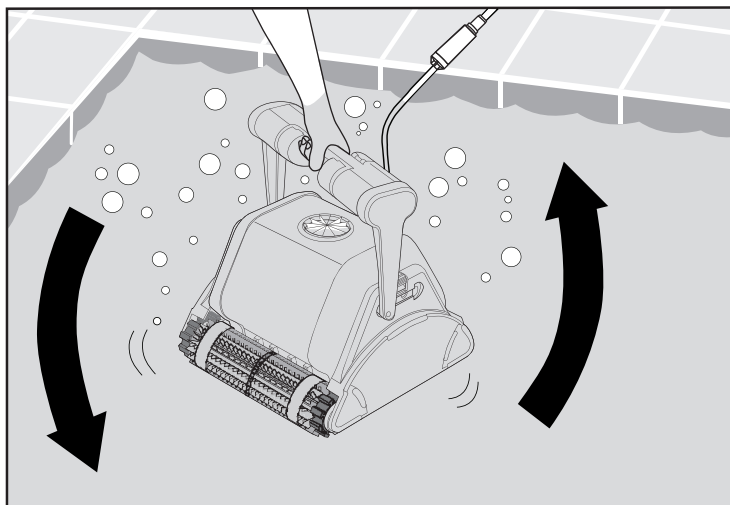

Ligue (ON) a fonte de alimentação

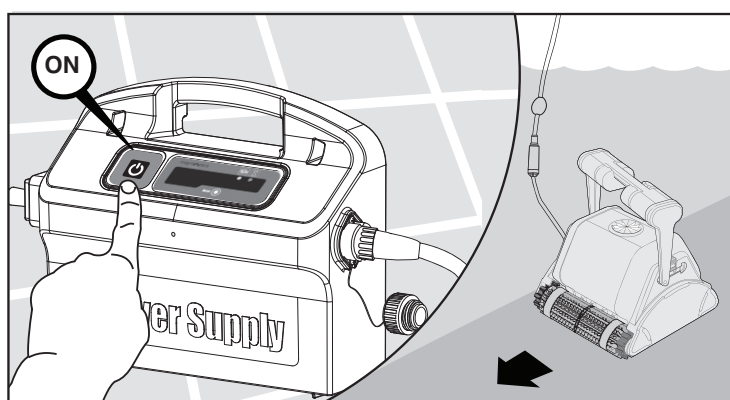

## 5.3. Retirar o aspirador da piscina

O robô desligará automaticamente no fim do ciclo de limpeza.

 Desligue (OFF) e retire a ficha da fonte de alimentação

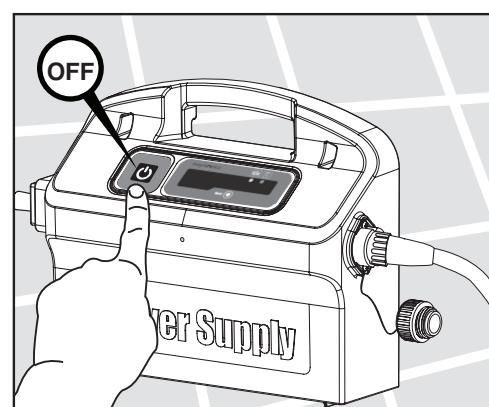

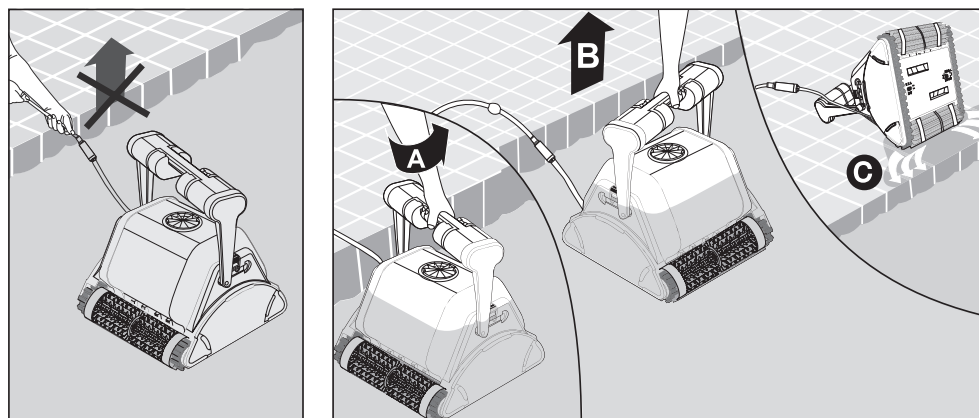

Utilizando o cabo flutuante, traga o aspirador até à borda da piscina.

**!** NÃO RETIRE O ASPIRADOR DA PISCINA UTILIZANDO O CABO

## 5.4. Manutenção

Limpe o saco de filtro com uma mangueira.  
Limpar periodicamente as escovas com uma mangueira.

Recomenda-se lavar periodicamente o saco de filtragem em uma máquina de lavar.  
Utilize o programa de limpeza sintética.

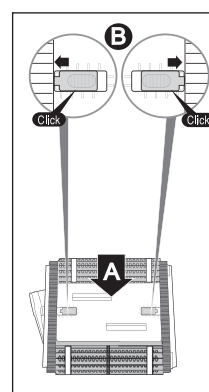
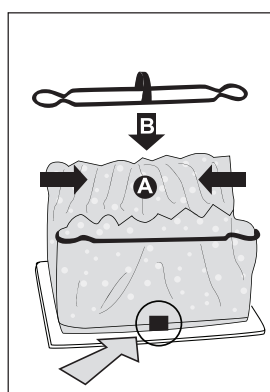
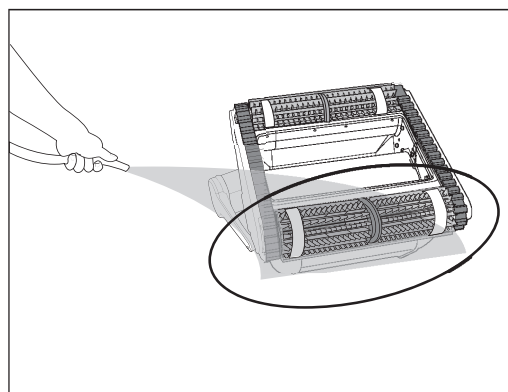
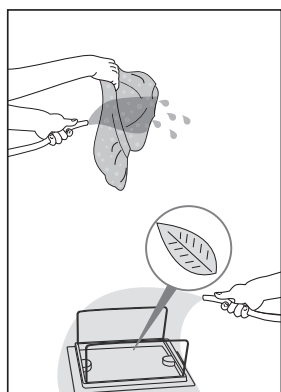
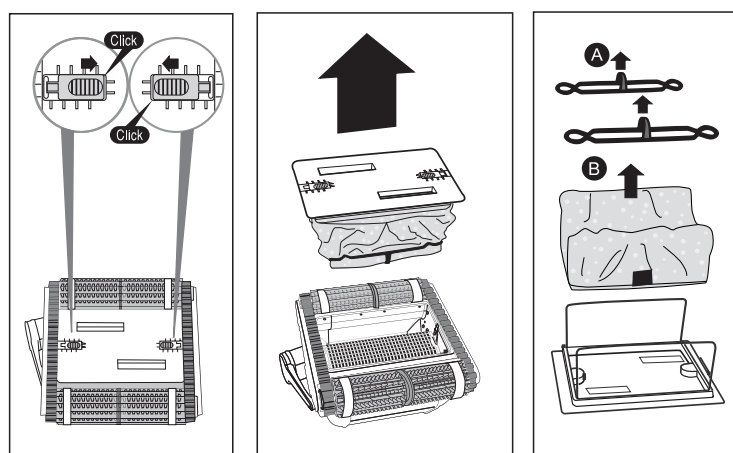

## Limpeza do impulsor

**⚠ Desligue a fonte de alimentação da tomada**

Se observar detritos presos no impulsor, abra-o e remova os detritos.

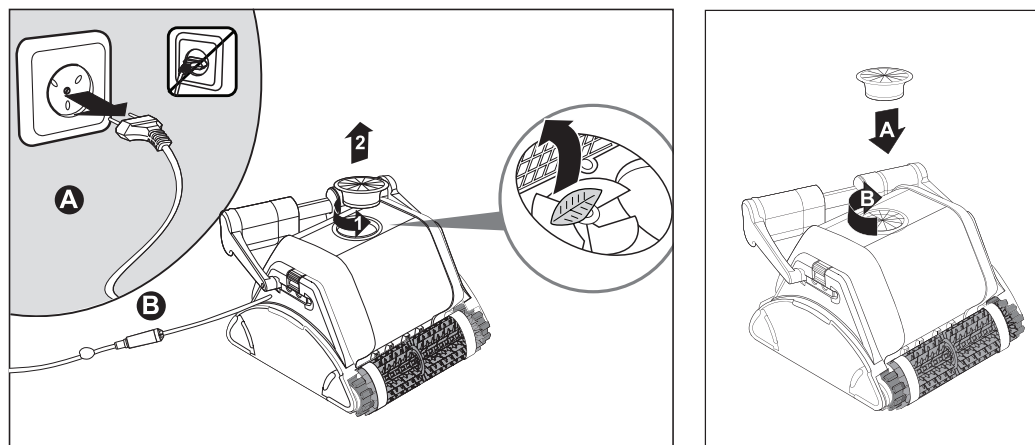

## Cabo

Para remover os torções deve esticar o cabo completamente e deixá-lo exposto ao sol por pelo menos um dia.

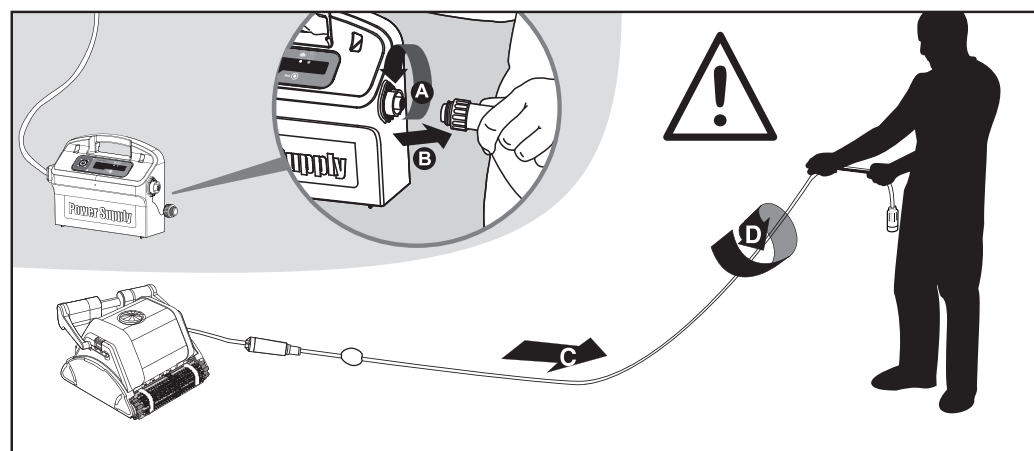

## 5.5. Armazenamento fora de época

Se o aspirador de piscina não for utilizado por um longo período, execute as seguintes fases de armazenamento:

- Certifique-se que não permanece nenhuma água no aspirador de piscina
- Limpe cuidadosamente o saco de filtro e insira-o na sua posição
- Enrole o cabo de modo a que fique sem torções e coloque-o sobre o Caddy
- Armazene o aspirador de piscina numa área protegida, no seu Caddy ou simplesmente virado ao contrário



## 6. FONTE DE ALIMENTAÇÃO

Fonte de Alimentação com Modo de Câmbio Digital, com bolso de filtro cheio e indicador de atraso.

- Input - 100-250 AC Volts
- 50-60 Hertz
- 180 Watt
- Output - <30 VDC
- IP 54

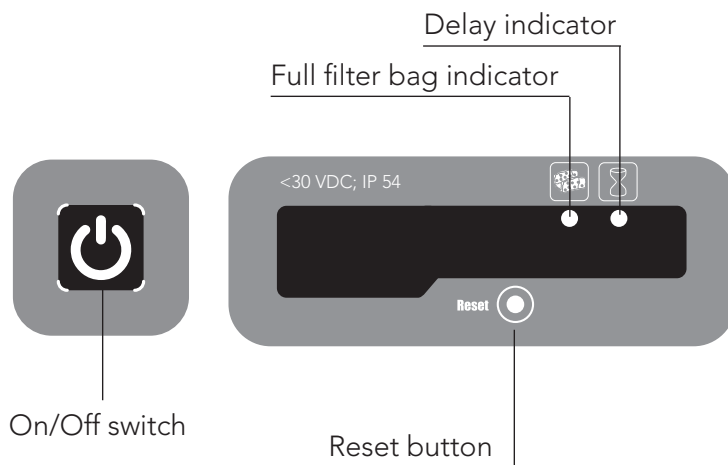
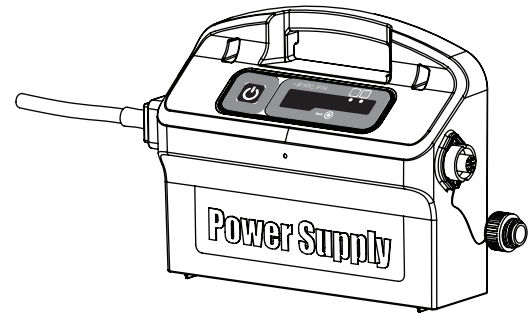

### Indicador do saco de filtro cheio e botão Reset

A fonte de alimentação é equipada com um indicador do estado do saco do filtro.

O LED vermelho indica duas condições do filtro.

- Quando está piscando – o saco do filtro está parcialmente bloqueado.
- Quando está aceso – o filtro está bloqueado e deve ser esvaziado e limpo.

Se o LED não se apaga depois do saco de filtro ter sido esvaziado e limpo, pressione o botão Reset enquanto o robô estiver funcionando.



### Indicador de atraso (Delay)

A fonte de alimentação está equipada com um indicador de atraso que indica se a opção de atraso está ativada (através da unidade de controle remoto).

## 7. CONTROLO REMOTO (RCU)

### O Painel de Controlo da Unidade de Controlo Remoto

A RCU oferece dois modos de operação – Modo Automático e Modo Manual de Controlo de direcção.

No modo Automático, todos os parâmetros de limpeza podem ser modificados.

No modo Manual de direcção, a direcção do Limpador de Piscinas pode ser controlada manualmente.

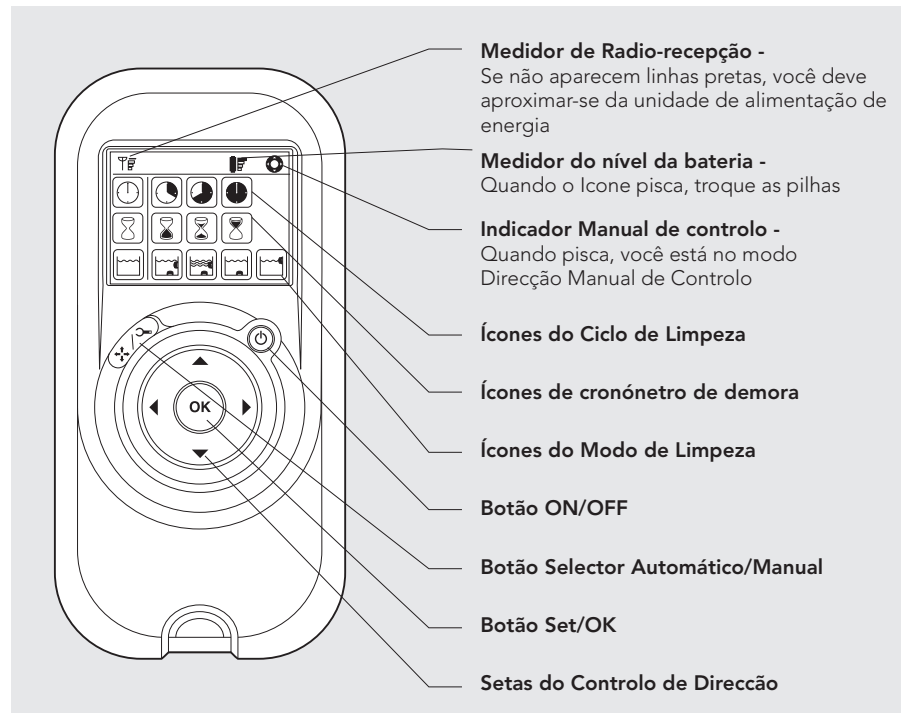

#### Modo Manual de Controlo de Direcção

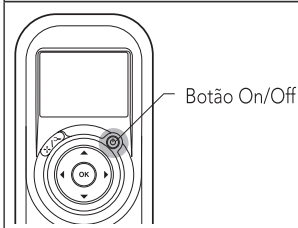

1. Pressione o botão ON/OFF uma vez - A RCU iniciará no modo Manual de Controlo de Direcção.
2. Para controlar manualmente a direcção do limpador, use as setas de controlo de direcção (ver à direita).

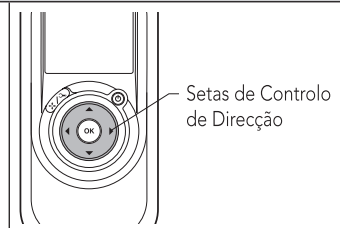

#### Sair do Modo Manual de Controlo de Direcção e Configurar o Modo Automático

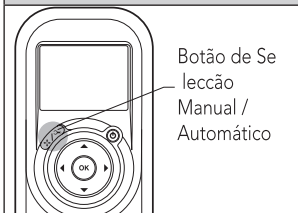



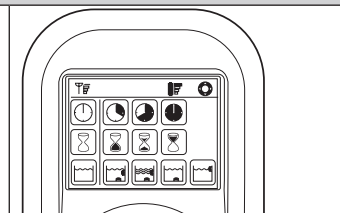



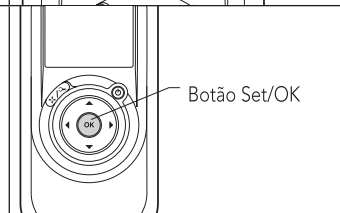





1. Para sair do modo Manual de controlo de direcção, pressione o botão de Seleção Manual/Automático apenas UMA VEZ.
2. O ecrã digital ilumina-se e três linhas de ícones de função aparecem no modo pré-determinado.



1. Para modificar os parâmetros pressione as setas para cima e para baixo. Para escolher a configuração dos parâmetros, use as setas da direita ou da esquerda.
2. Quando obtiver a função desejada, pressione o botão Set/OK.



Primeiro pressione o botão de selecção Manual/Automático, depois configure de acordo com a tabela seguinte:

 <p><b>Indicador do Ciclo de Limpeza</b> Este determina o tempo do ciclo de limpeza. A RCU permite escolher entre as opções seguintes.</p>	 <p><b>Rápido</b> Ciclo de 4 horas</p>	 <p><b>Eficiente (Configuração pré-determinada)</b> Ciclo de 6 horas para uso diário</p>	 <p><b>Extra</b> Ciclo de 8 horas</p>	
 <p><b>Indicador do Tempo de Início Retardado</b> Este determina quando o limpador de piscina começa a operar. Um início retardado permite que a sujidade se deposite no fundo da piscina.</p>	 <p><b>Início imediato (Configuração pré-determinada)</b></p>	 <p><b>Início Retardado em Uma Hora</b></p>	 <p><b>Início Retardado em Duas Horas</b></p>	
 <p><b>Indicador da Acção de Limpeza</b> Permite a escolha entre as opções seguintes.</p>	 <p><b>Padrão</b> Limpeza de piso e parede. <b>(Configuração pré-determinada)</b></p>	 <p><b>Ultra-limpo</b> Maior sucção e movimento mais lento. (piso e parede)</p>	 <p><b>Somente Piso</b> Limpa somente o piso e as cavidades.</p>	 <p><b>Somente Paredes</b> Limpa somente as paredes e a linha de água.</p>

**Nota:**

- Depois de decorridos 2 minutos, se nenhum botão for pressionado, a Unidade de Controlo Remoto desliga-se e o Limpador de Piscina continua a operar na configuração anterior.
- Quando as opções "Ultra-Limpo" e "Somente Paredes" concluem os seus ciclos, a Limpador de Piscina retorna à configuração pré-estabelecida.



**RU**

## **Dolphin PROX 2 Gyro очиститель бассейнов** **Руководство по эксплуатации**

### **Содержание**

1. ВВЕДЕНИЕ .....	72
2. ТЕХНИЧЕСКИЕ ХАРАКТЕРИСТИКИ .....	72
3. ПРЕДОСТЕРЕЖЕНИЯ И МЕРЫ ПРЕДОСТОРОЖНОСТИ .....	72
3.1. Предостережения .....	72
3.2. Меры предосторожности .....	72
4. ЧАСТИ РОБОТА ДЛЯ ОЧИСТКИ БАССЕЙНОВ .....	73
5. ИСПОЛЬЗОВАНИЕ РОБОТА ДЛЯ ОЧИСТКИ БАССЕЙНОВ .....	74
5.1. Настройки .....	74
5.2. Погружение робота для очистки в бассейн .....	75
5.3. Извлечение робота для очистки из бассейна .....	75
5.4. Техобслуживание .....	76
5.5. ВНЕСЕЗОННОЕ ХРАНЕНИЕ .....	77
6. ИСТОЧНИК ПИТАНИЯ .....	78
7. ПУЛЬТ ДИСТАНЦИОННОГО УПРАВЛЕНИЯ .....	79
CADDY АССАМБЛЕИ .....	81

# Dolphin PROX 2 Gyro очиститель бассейнов

## Руководство по эксплуатации

### 1. ВВЕДЕНИЕ

Благодарим за приобретение робота для очистки бассейнов Maytronics.

Мы уверены, что Ваш робот Maytronics обеспечит надежную, удобную и малозатратную очистку бассейна. Максимальный результат достигается благодаря надежной системе фильтрации независимо от условий бассейна, активному использованию щеток, а также наличию щетки, работающей на любой поверхности.

Роботы для очистки бассейнов Maytronics сочетают в себе новейшие технологии очистки, исключительные рабочие характеристики и легкость технического обслуживания. Вы и ваша семья сможете наслаждаться плаванием с полной уверенностью в том, что бассейн абсолютно чист.

### 2. ТЕХНИЧЕСКИЕ ХАРАКТЕРИСТИКИ

Защита мотора: IP 68

Минимальная глубина: 0.80м/2.6фут.

Максимальная глубина: 5м/16.4фут.

### 3. ПРЕДОСТЕРЕЖЕНИЯ И МЕРЫ ПРЕДОСТОРОЖНОСТИ



#### 3.1. Предостережения

- Используйте только оригинальный источник питания
- Убедитесь в том, что электрический выход защищен устройством защитного отключения (УЗО) или прерывателем замыкания на землю (ПЗЗ)
- Храните источник питания вдали от воды
- Расположите источник питания по меньшей мере в 3м/10фут. от края бассейна
- Не входите в бассейн, если в нем работает робот для очистки
- Отключайте источник питания перед проведением сервисного обслуживания

#### 3.2. Меры предосторожности

В перерывах между использованием храните робот для очистки в ящике для хранения в затененном месте.

Характеристики воды для использования робота:

Хлор	Макс. 4 мг/м3
pH	7.0 - 7.8
Температура	6 – 34°C (43-93°F)
NaCl	Максимум = 5000 мг/м3

#### 4. ЧАСТИ РОБОТА ДЛЯ ОЧИСТКИ БАССЕЙНОВ

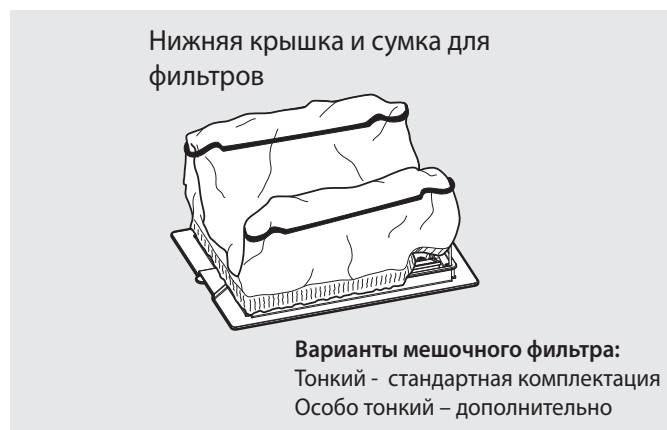
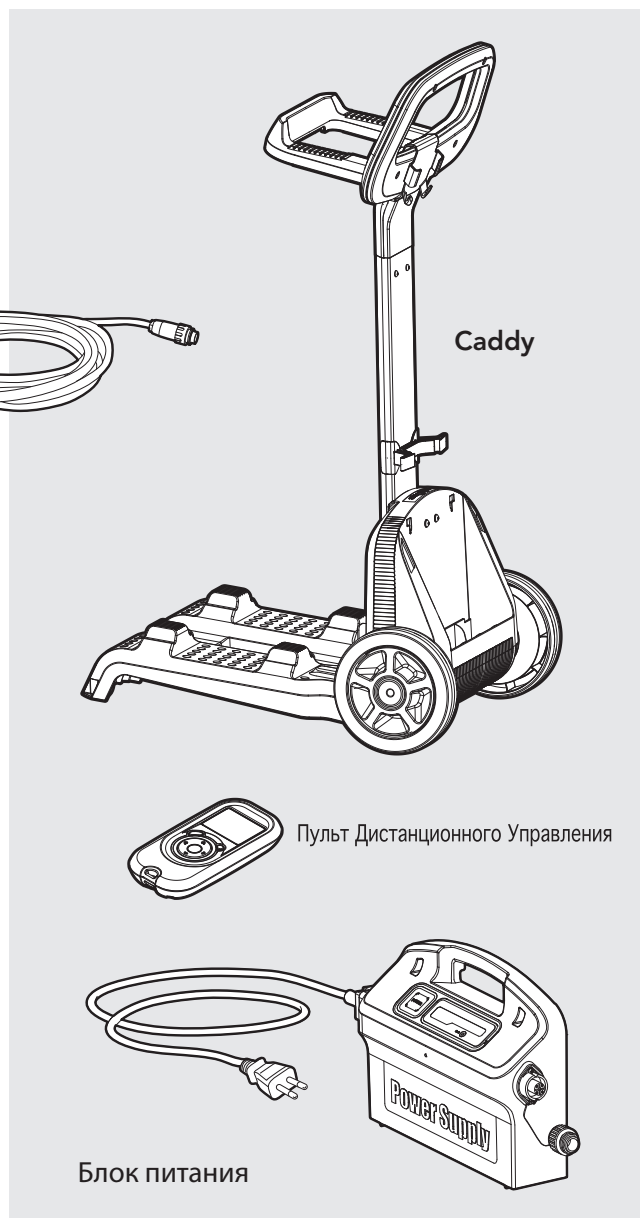
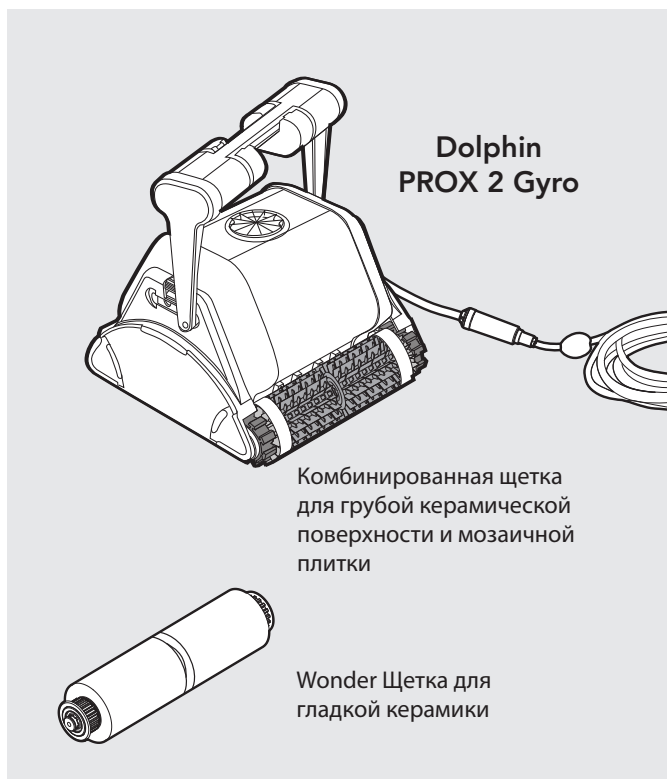

## 5. ИСПОЛЬЗОВАНИЕ РОБОТА ДЛЯ ОЧИСТКИ БАССЕЙНОВ

### 5.1. Настройки

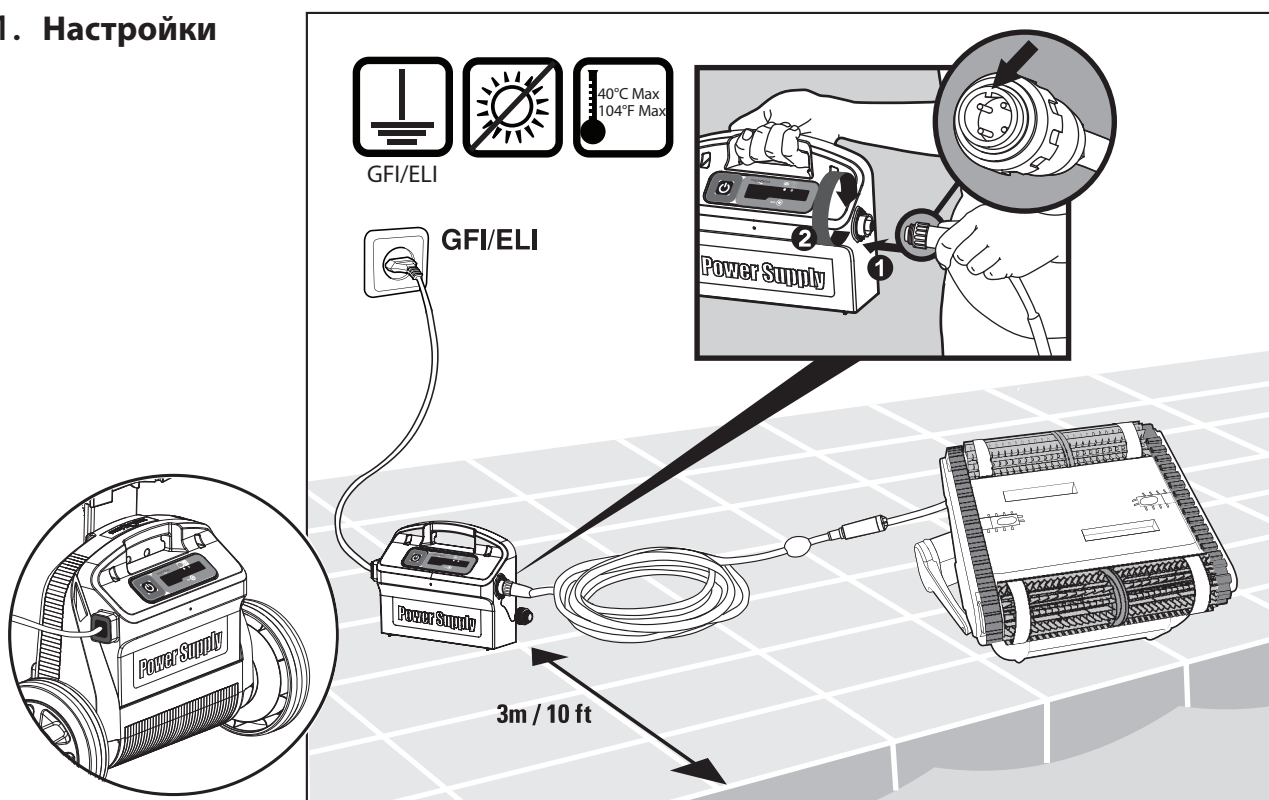

Измените диагональное положение рукоятки для бокового движения водяной линии.

Для регулировки угла ручки:

- A.** Нажмите на защелку и удерживайте ее в этом положении.
- B.** Переместите ручку в нужное положение и отпустите защелку, чтобы поставить ручку на место.

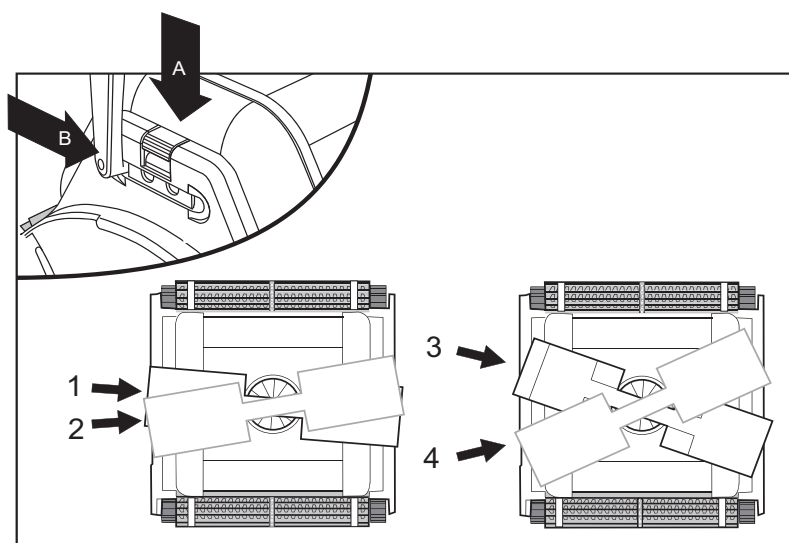

## 5.2. Погружение робота для очистки в бассейн

Если Wonder щетки/Wonder кольца сухие, намочите их, чтобы они стали магкими.

Потрясти робот из стороны в сторону или перевернуть его для удаления скопившегося внутри воздуха. Позвольте устройству опуститься на дно бассейна.

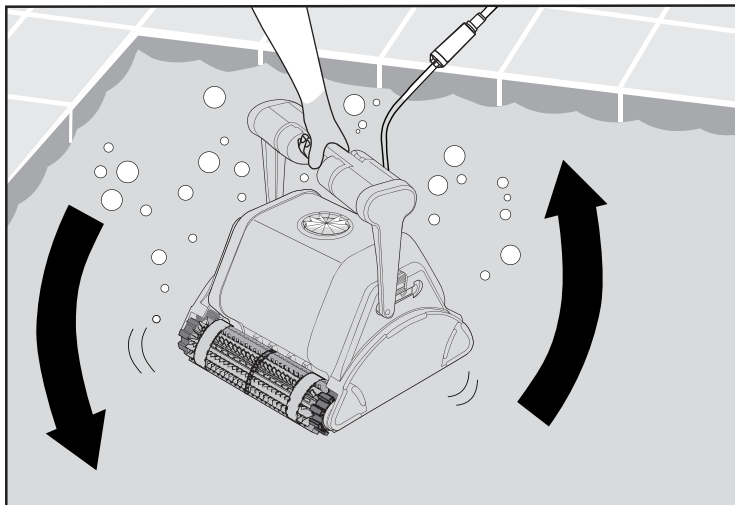

Робот выполнит рабочий цикл

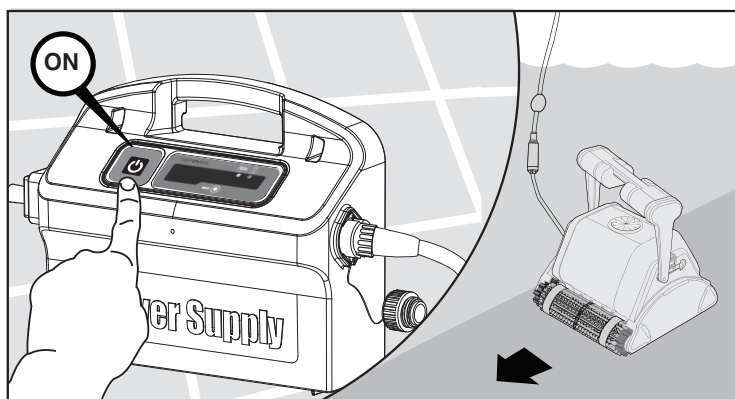

## 5.3. Извлечение робота для очистки из бассейна

Робот автоматически отключает систему по завершении цикла очистки.



Выключите питание и отсоедините источник питания

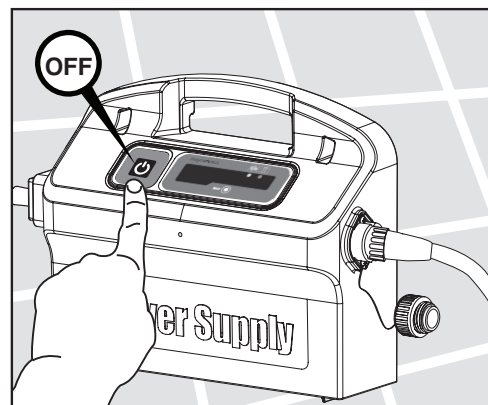

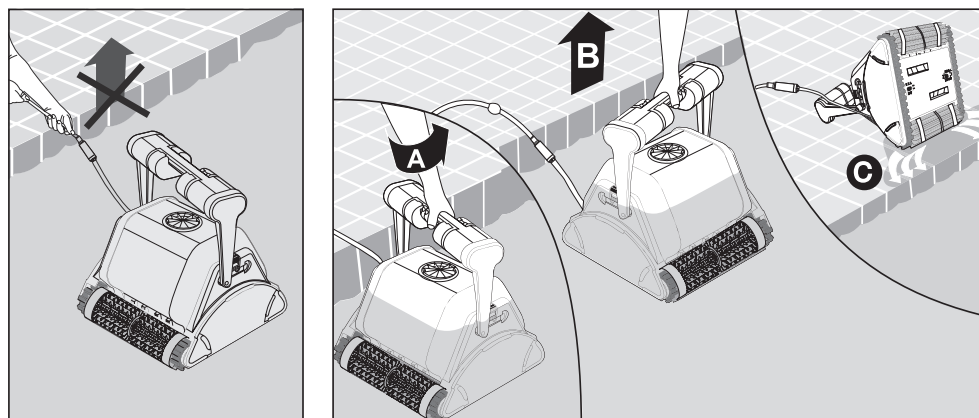

Подтяните робот к краю с помощью плавающего кабеля.



НЕ ВЫТАСКИВАЙТЕ РОБОТ ИЗ БАСЕЙНА С ПОМОЩЬЮ КАБЕЛЯ

### 5.4. Техобслуживание

Промойте мешок фильтра из шланга. Периодически промывайте щетки из шланга.

Рекомендуется периодически промывать мешок фильтра в стиральной машине. Использовать программу для стирки синтетических материалов.

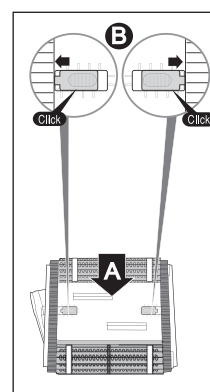
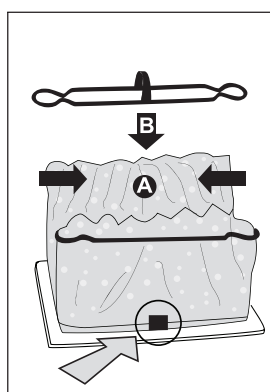
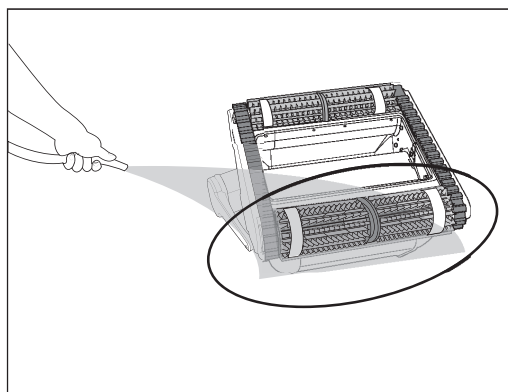
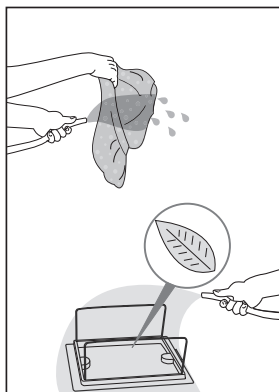
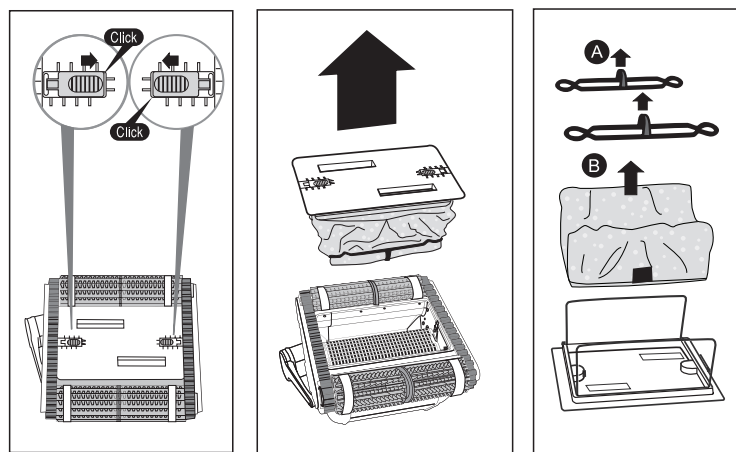

## Очистка рабочего колеса

**!** Отсоедините источник питания

При попадании мусора в рабочее колесо, откройте рабочее колесо и удалите мусор.

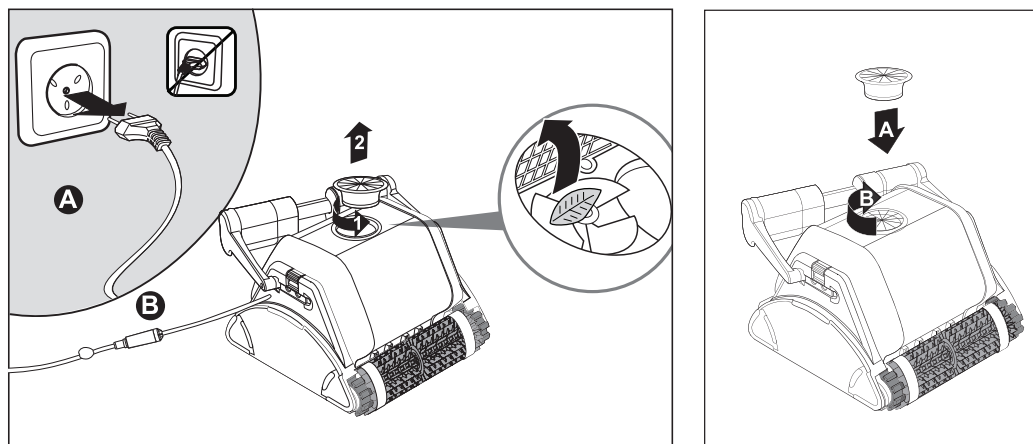

## Кабель

Чтобы удалить заломы, распрямите кабель и оставьте на солнце на день.

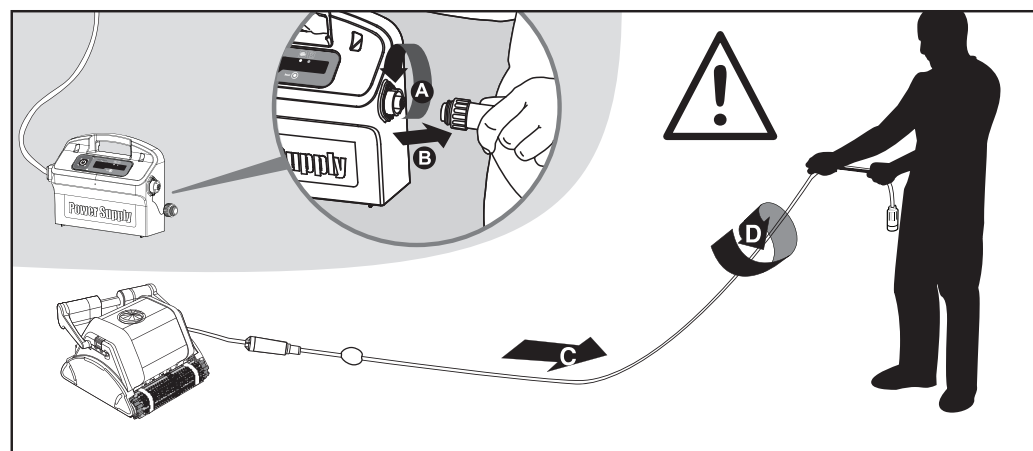

## 5.5. ВНЕСЕЗОННОЕ ХРАНЕНИЕ

Если использование робота не предполагается в течение продолжительного периода времени, выполните следующие шаги:

- Убедитесь, что в роботе не осталось воды
- Тщательно очистите мешки или картриджи фильтра и установите их на место
- Смотайте кабель так, чтобы на нем не было заломов и поместите его в ящик для хранения
- Храните робот в закрытом месте в ящике для хранения или просто в перевернутом состоянии

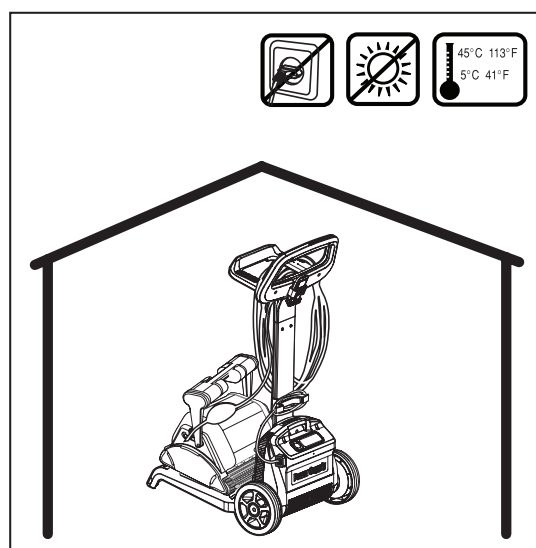

## 6. ИСТОЧНИК ПИТАНИЯ

Цифровой переключаемый источник питания с индикатором наполнения мешочного фильтра и задержки.

- Input - 100-250 AC Volts
- 50-60 Hertz
- 180 Watt
- Output - <30 VDC
- IP 54

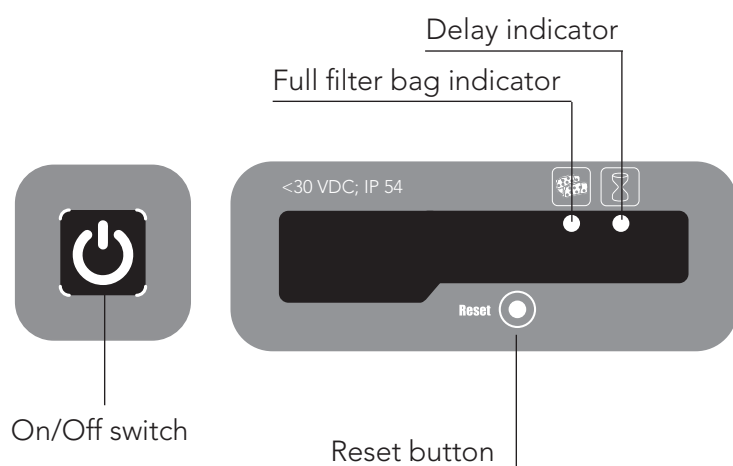
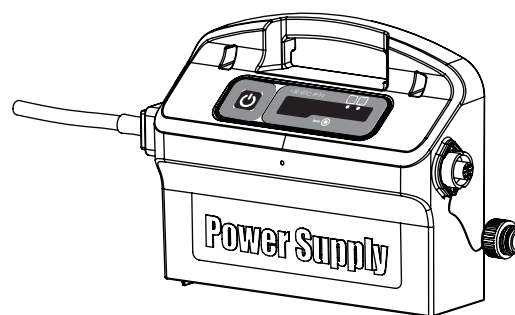

### Индикатор наполнения мешочного фильтра и кнопка сброса (Reset)

Блок питания оснащен индикатором состояния мешочного фильтра.

Красный светодиод указывает на два состояния фильтра.

- При мигании – мешочный фильтр частично засорен.
- При свечении - фильтр засорен и должен быть освобожден и очищен.

Если светодиод не выключается после опустошения и очистки мешочного фильтра, нажмите на кнопку сброса в то время работы робота.



### Индикатор задержки (Delay)

Блок питания оснащен индикатором задержки, который указывает, если активирован вариант с задержкой (через пульт дистанционного управления).



## 7. ПУЛЬТ ДИСТАНЦИОННОГО УПРАВЛЕНИЯ

### Панель управления ПДУ

ПДУ предоставляет два вида режима управления - Автоматический и ручной. В автоматическом режиме работы можно изменять все параметры чистки. В ручном режиме работы, движение робота управляется в ручную.

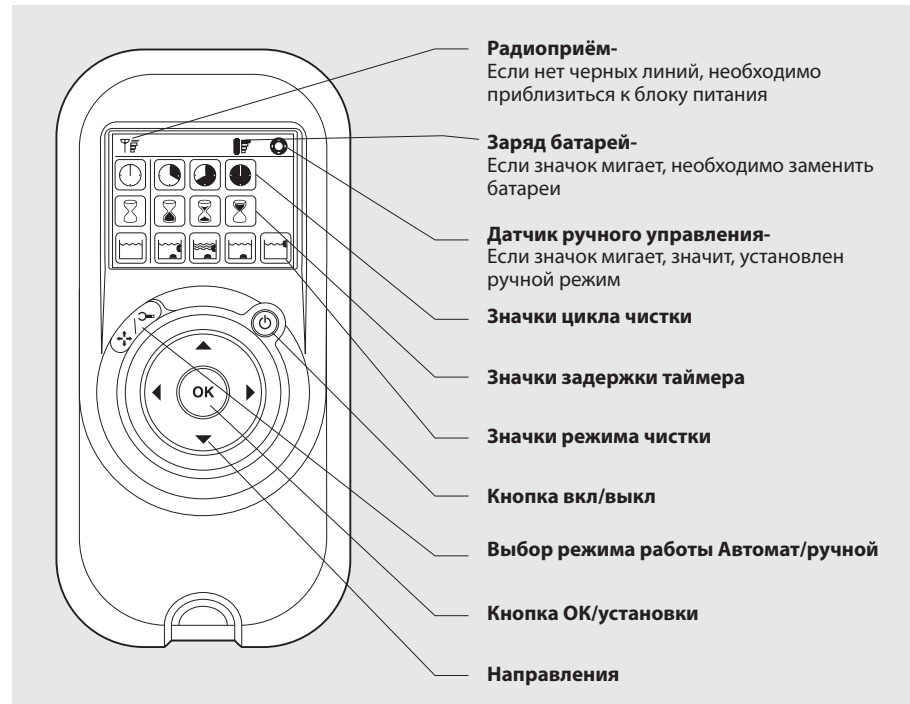

### Ручное управление робота

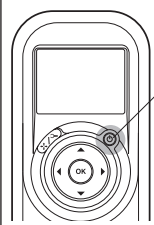

Кнопка вкл./выкл.

1. Нажми кнопку вкл./выкл., один раз - ПДУ запустится в ручном режиме управления
2. Для ручного управления используй стрелки направления движения - см. справа

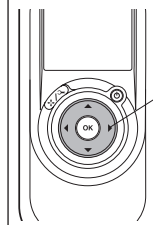

Стрелки направления движения

### Выход из ручного режима и установка автоматического режима

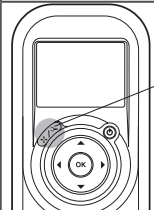

Кнопка выбора режима

1. Для выхода из Ручного режима работы, необходимо нажать один раз на кнопку Выбора режима.
2. Цифровой экран загорится и в трёх рядах функций высветятся значки вазовых установок

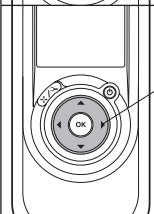
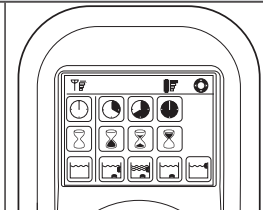





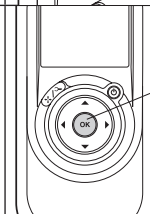







Стрелки направления движения

1. Для изменения параметров нажми на стрелки вверх/вниз Для выбора параметра нажми на стрелки вправо/влево
2. Для установки желаемой функции нажми кнопку ОК/установка



Кнопка установки/ОК

Сначала нажми на кнопку выбора режима, затем выбери необходимые установки в соответствии с таблицей

 <p><b>Датчик цикла чистки</b> Определение цикла чистки. ПДУ позволяет выбрать один из следующих вариантов</p>	 <p><b>Быстрый</b> 4 часа</p>	 <p><b>Эффективный (Базовая установка)</b> 6 часа для ежедневного использования</p>	 <p><b>Экстра</b> 8 часа</p>	
 <p><b>Датчик задержки таймера</b> Определение, когда робот начал работу. Задержка позволяет мусору осесть на дно бассейна</p>	 <p><b>Немедленное начало (Базовая установка)</b></p>	 <p><b>Один час задержки</b></p>	 <p><b>Два часа задержки</b></p>	
 <p><b>Датчик действий</b> Позволяет выбрать один из следующих вариантов</p>	 <p><b>Стандарт Чистка дна и стен (Базовая установка)</b></p>	 <p><b>Усиленная чистка</b> Усиленное всасывание и медленное движение</p>	 <p><b>Только дно</b> Чистка дна и стыков</p>	 <p><b>Только стены</b> Чистит только стены и линию воды</p>





**Заметка:**

- После 2 минут, если не нажата кнопка, ПДУ выключится, и робот будет продолжать работать в предыдущих настройках.
- Когда циклы работы, с выбранными опциями "Усиленная чистка" и "Только стены", закончатся, вернётся к базисным установкам.

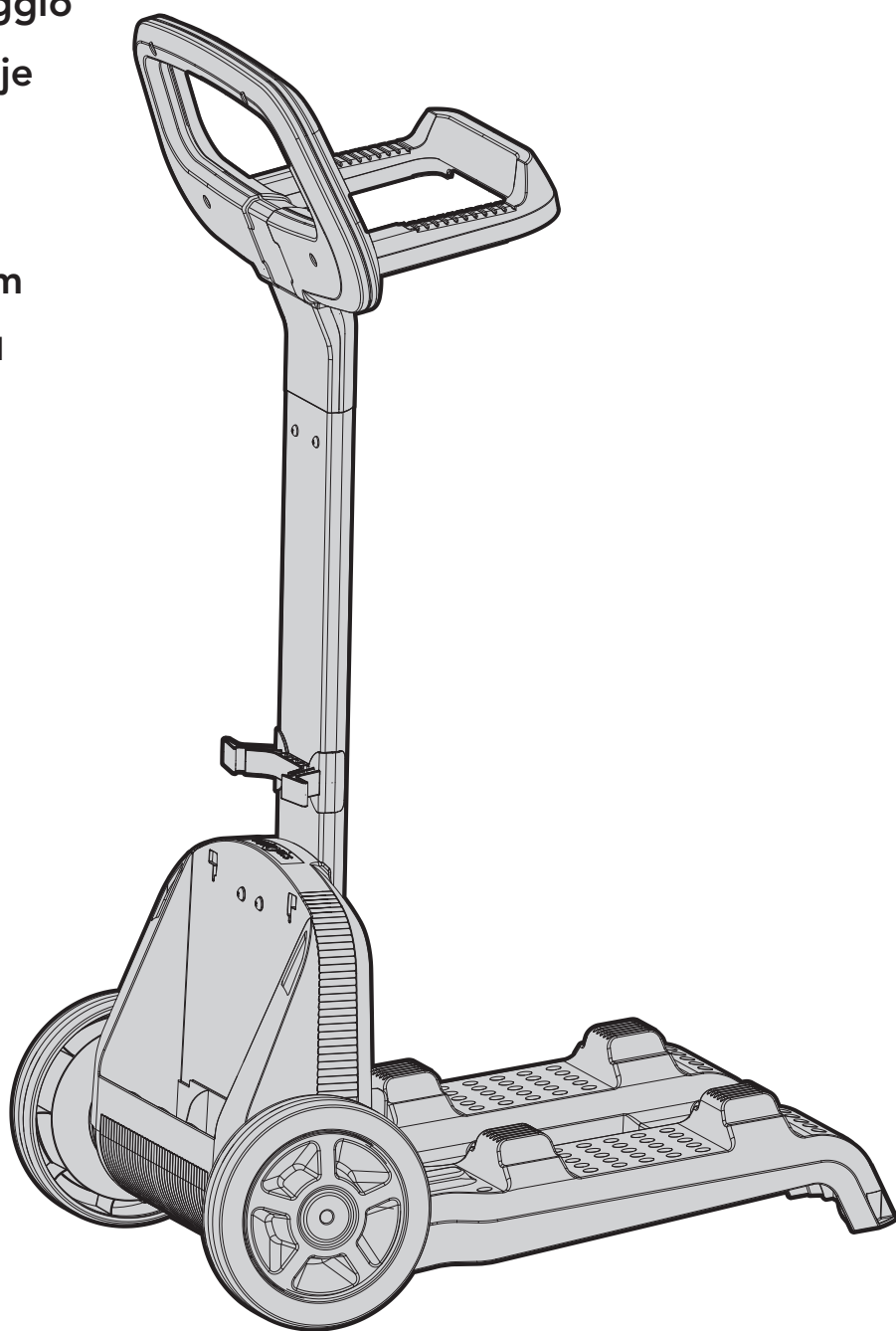
## Dolphin PROX 2 Gyro Pool Cleaner

- EN Caddy assembly
- FR Caddy de montage
- IT Caddy di montaggio
- ES Caddy de montaje
- DE Caddy montage
- NL Caddy montage
- PT Caddy montagem
- RU CADDY АССАМБЛЕИ



①	DIN 7985 A2 M5X35		x 2
②	DIN 127B A2 M5		x 2
③	DIN 1587 A2 M5		x 2
④	WN 1412 A2 KA50X16		x 6

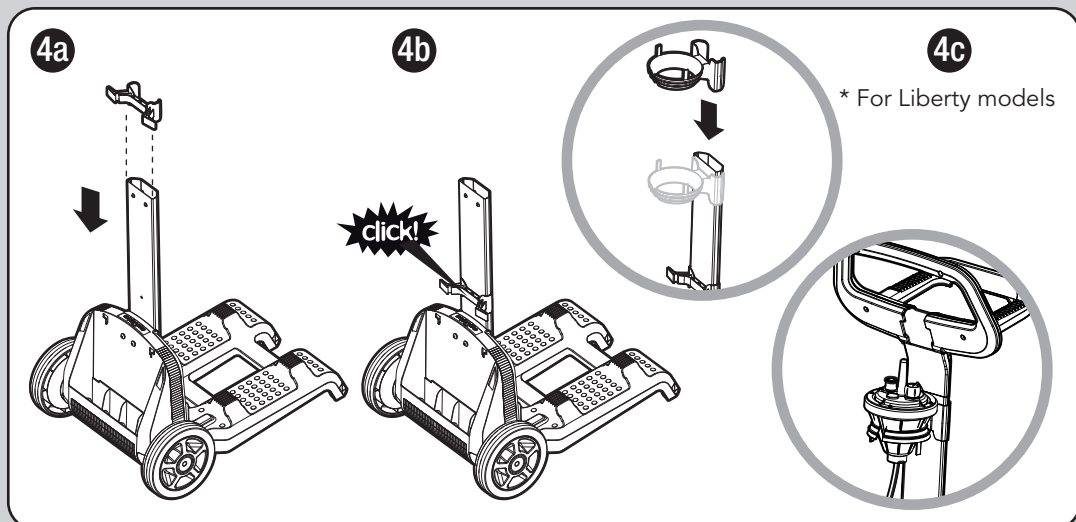
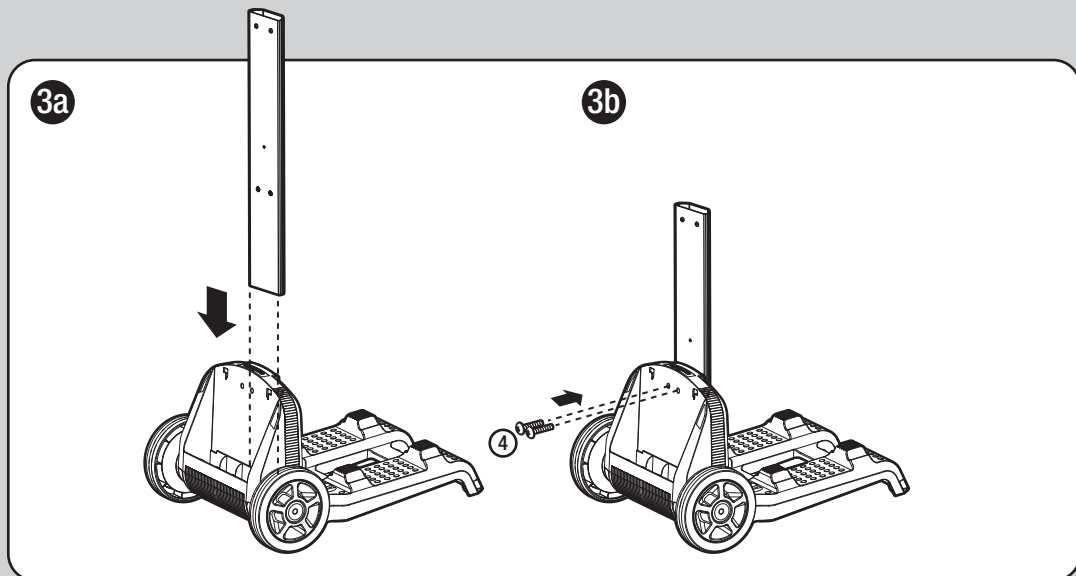
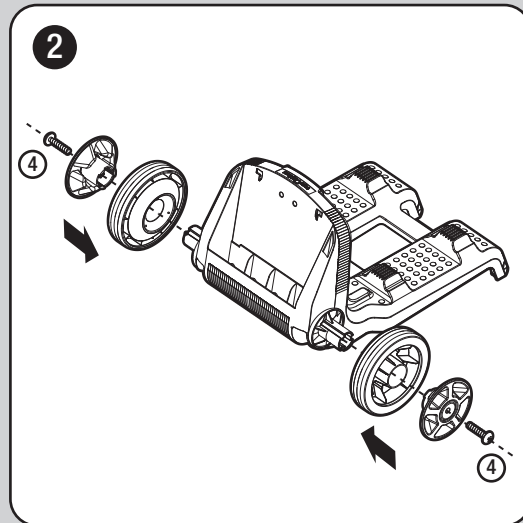
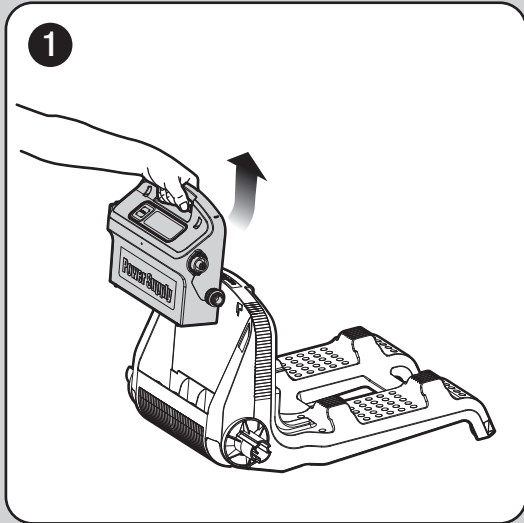

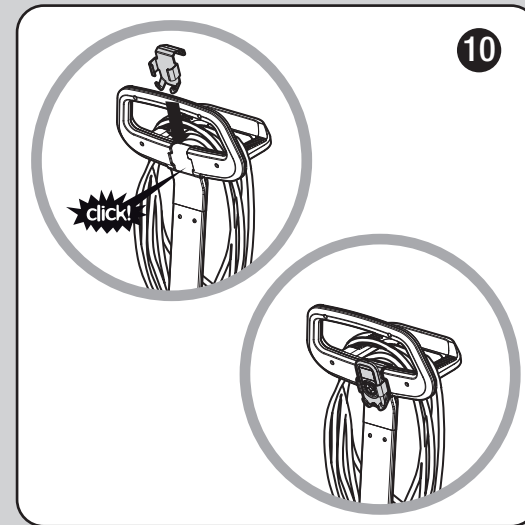
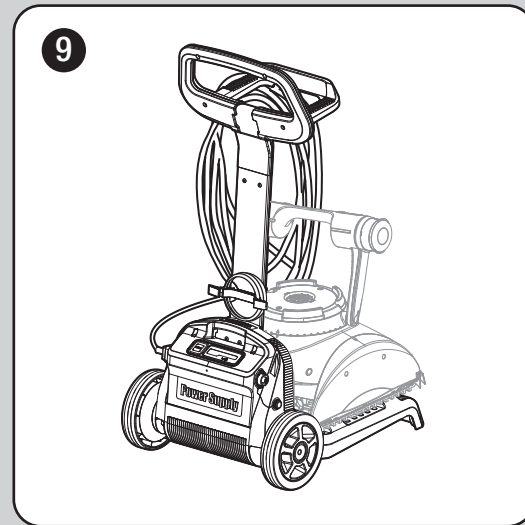
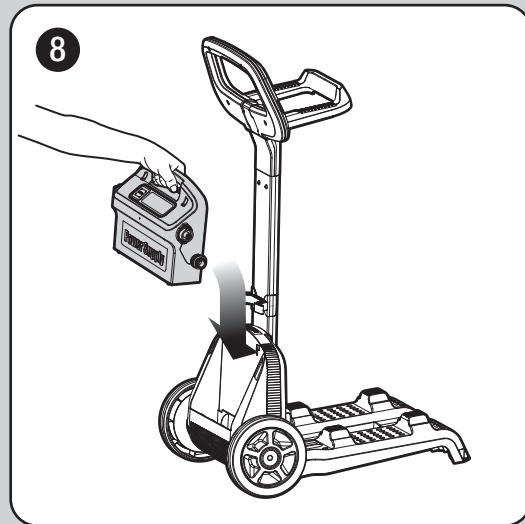
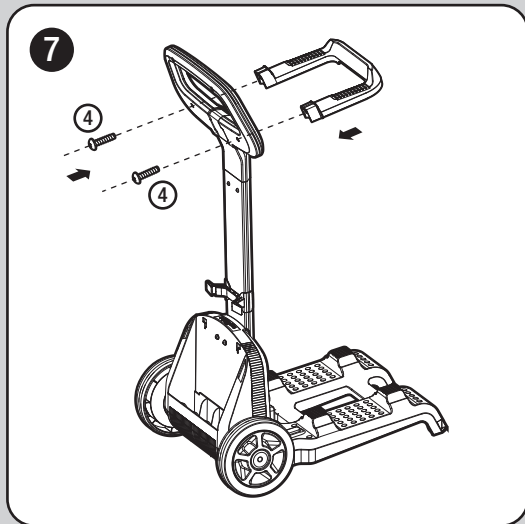
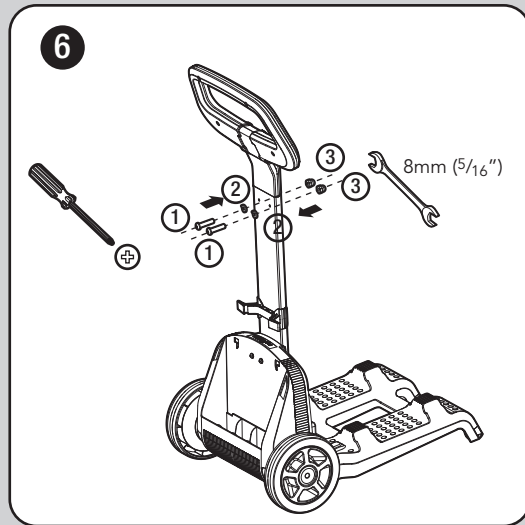
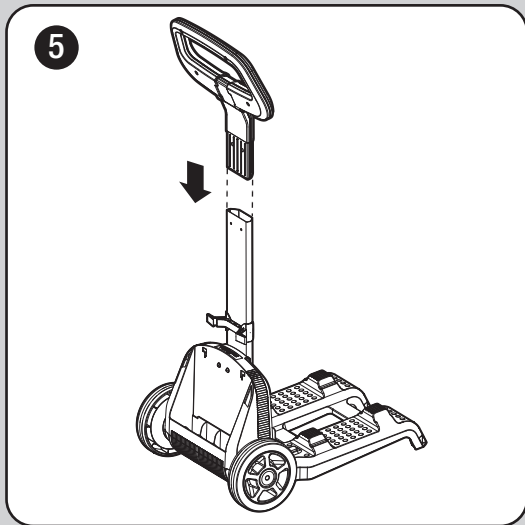





# Dolphin PROX 2 GYRO Pool Cleaner